

➤ Instructions

Thule Elm

i-Size rear and forward facing toddler seat

67 cm - 105 cm / max 18 kg



UNR129/03



Bring your life
thule.com

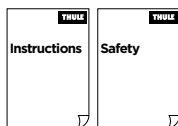

EN

IMPORTANT - READ CAREFULLY AND KEEP FOR FUTURE REFERENCE. DEATH OR SERIOUS INJURY CAN OCCUR IF YOU DO NOT FOLLOW THESE INSTRUCTIONS.

READ THE SAFETY MANUAL FOR THULE ELM TODDLER CAR SEAT BEFORE USE AND KEEP FOR FUTURE REFERENCE.

THIS PRODUCT MAY NOT FIT IN ALL RECLINE POSITIONS IN AN APPROVED VEHICLE.

FR

IMPORTANT - LISEZ ATTENTIVEMENT CES INSTRUCTIONS ET CONSERVEZ-LES POUR RÉFÉRENCE FUTURE. LE NON-RESPECT DE CES INSTRUCTIONS POURRAIT PROVOQUER DES BLESSURES GRAVES, VOIRE MORTELLES.

LISEZ LE MANUEL DE SÉCURITÉ DU SIÈGE AUTO POUR ENFANT THULE ELM AVANT UTILISATION ET CONSERVEZ-LE POUR RÉFÉRENCE FUTURE.

DANS LES VÉHICULES APPROUVÉS, IL SE PEUT QUE CE PRODUIT NE S'ADAPTE PAS À TOUTES LES POSITIONS INCLINÉES.

ES

IMPORTANTE - LEER LAS INSTRUCCIONES CUIDADOSAMENTE ANTES DEL USO Y MANTEN-ERLAS PARA FUTURAS CONSULTAS. SI NO SIGUE ESTAS INSTRUCCIONES, PUEDEN PRODUCIRSE LESIONES GRAVES O LA MUERTE.

LEA EL MANUAL DE SEGURIDAD DE LA SILLA DE AUTOMÓVIL PARA NIÑOS PEQUEÑOS THULE ELM ANTES DE USARLA Y GUÁRDELO PARA FUTURAS CONSULTAS.

ESTE PRODUCTO PUEDE NO AJUSTARSE EN TODAS LAS POSICIONES RECLINADAS EN UN VEHÍCULO APROBADO.

DE

WICHTIG - LESEN SIE DIESE ANLEITUNG SORGFÄLTIG DURCH UND BEWAHREN SIE ZUM NACHSCHLAGEN AUF. DIE NICHTBEACHTUNG DIESER ANWEISUNGEN KANN ZUM TOD ODER ZU SCHWEREN VERLETZUNGEN FÜHREN.

LIES VOR DER BENUTZUNG DAS SICHERHEITSHANDBUCH FÜR DEN THULE ELM KLEINKINDERSITZ DURCH UND BEWAHRE ES ZUM SPÄTEREN NACHSCHLAGEN AUF.

IN BESTIMMTEN ZUGELASSENEN FAHRZEUGEN KÖNNEN NICHT ALLE NEIGUNGSPOSITIONEN DES PRODUKTS GENUTZT WERDEN.

NL

IBELANGRIJK - LEES DE GEBRUIKSAANWIJZING ZORGVULDIG DOOR EN BEWAAR DEZE VOOR LATER GEBRUIK. ALS U DEZE INSTRUCTIES NIET OPVOLGT, KAN DIT DOOD OF ERNSTIG LETSEL TOT GEVOLG HEBBEN.

LEES VOOR HET GEBRUIK VAN HET THULE ELM AUTOSTOELTJE VOOR PEUTERS DE VEILIGHEIDSLINSTRUCTIES EN BEWAAR DEZE OM ZE IN DE TOEKOMST TE KUNNEN NASLAAN.

DIT PRODUCT PAST MOGELIJK NIET IN ALLE LIGPOSITIES IN EEN GOEDGEKEURD VOERTUIG.

PT

IMPORTANTE - LER CUIDADOSAMENTE AS INSTRUÇÕES ANTES DE USAR E GUARDÁ-LAS PARA FUTURA REFERÊNCIA. MORTE OU FERIMENTOS GRAVES PODERÃO OCORRER SE VOCÊ NÃO SEGUIR ESSAS INSTRUÇÕES.

LEIA O MANUAL DE SEGURANÇA DO ASSENTO AUTOMÓVEL PARA CRIANÇAS MAIS CRESCIDAS THULE ELM ANTES DE UTILIZAR O PRODUTO E GUARDE-O PARA REFERÊNCIA FUTURA.

ESTE PRODUTO PODE NÃO CABER EM TODAS AS POSIÇÕES RECLINADAS NUM VEÍCULO APROVADO.

IT

IMPORTANTE - LEGGERE ATTENTAMENTE LE ISTRUZIONI PRIMA DELL'USO E CONSERVARLE PER FUTURO RIFERIMENTO. MORTE O LESIONI GRAVI POSSONO VERIFICARSI SE NON SI SEGUONO QUESTE ISTRUZIONI.

LEGGERE IL MANUALE DI SICUREZZA PER IL SEGGIOLINO AUTO PER BAMBINI THULE ELM PRIMA DELL'USO E CONSERVARLO PER RIFERIMENTO FUTURO.

QUESTO PRODOTTO POTREBBE NON ADATTARSI A TUTTE LE POSIZIONI RECLINATE DI UN VEICOLO OMOLOGATO.

SV

VIKTIG - LÄS ANVISNINGARNA NOGA FÖRE ANVÄNDNING. DÖDSFALL ELLER ALLVARLIG SKADA KAN INTRÄFFA OM DU INTE FÖLJER DE HÅR INSTRUKTIONERNA.

LÄS SÄKERHETSMANUALEN FÖR THULE ELM BILBARNSTOL FÖR SMÅBARN FÖRE ANVÄNDNING, OCH BEHÅLL DEN FÖR FRAMTIDA BRUK.

DENNA PRODUKT KANSKE INTE FÅR PLATS I ETT GODKÄNT FORDON I ALLA LUTNINGSLÄGEN.

DA

VIGTIGT - LÆS OMHYGGELIGT. GEM TIL FREMTIDIG BRUG. DU RISIKERER AT UDSÆTTE DIT BARN. DØD ELLER ALVORLIG PERSONSKADE KAN FOREKOMME, HVIS DU IKKE FØLGER DISSE INSTRUKTIONER.

LÆS SIKKERHEDSMANUALEN FOR THULE ELM AUTOSTOLEN FØR BRUG, OG GEM DEN TIL SENERE BRUG.

DETTE PRODUKT PASSER MULIGVIS IKKE I ALLE TILBAGELÆNEDE POSITIONER I DET GODKENDTE KØRETØJ.

NO

VIKTIG - TA VARE PÅ DISSE INSTRUKSJONENE, DU KAN FÅ BEHOV FOR DEM SENERE. DØD ELLER ALVORLIG SKADE KAN OPPSTÅ HVIS DU IKKE FØLGER DISSE INSTRUKSJONENE.

LES SIKKERHETSHÅNDBOKEN FOR THULE ELM BILSTOL FOR SMÅBARN FØR DU BRUKER DEN, OG OPPBEVAR HÅNDBOKEN FOR FREMTIDIG REFERANSE.

DETTE PRODUKTET PASSER KANSKJE IKKE I ALLE TILBAKELENTE POSISJONER I ET GODKJENT KJØRETØY.

FI

TÄRKEÄ - LUE OHJEET HUOLELLISESTI ENNEN KÄYTTÖÄ JA SÄILYÄ NE TULEVAAN KÄYTTÖÄ VARTEN. NÄIDEN OHJEIDEN NOUDATTAMATTA JÄTTÄMINEN VOI JOHTAA KUOLEMAAN TAI VAKAANAAN LOUKKAANTUMISEEN.

LUE TAAPERON THULE ELM -TURVAISTUIMEN TURVAOPAS ENNEN KÄYTTÖÄ JA SÄILYÄ SE VASTAISUUDEN VARALLE.

TÄMÄ TUOTE EI EHKÄ MAHDU HYVÄKSYTTYYN AJONEUVOON KAIKISSA KALLISTUSKULMISSA.

IS

MIKILVÆGT - GEYMIÐ ÞESSAR LEIÐBEININGAR TIL SÍÐARI NOTA. EF ÞESSUM LEIÐBEININGUM ER EKKI FYLGT GETUR ÞAÐ LEITT TIL DAUÐA EÐA ALVARLEGRÁ MEIÐSLA.

LESTU ÖRYGGISHANDBÓKINA FYRIR THULE ELM SMÁBARNABÍLSTÓL FYRIR NOTKUN OG GEYMDU TIL SÍÐARI NOTA.

EKKI ER VÍST AÐ ÞESSI VARA PASSI Í ÖLLUM HALLASTÖÐUM Í VIÐURKENNT ÖKUTÆKI.

ET

OLULINE - ENNE KASUTAMIST LOE TÄHELEPANELIKULT LÄBI KASUTUSJUHENDID JA HOIA NEED ALLES EDASPIDISEKS. JUHUL KUI TE KÕNEALUSEID JUHISEID EI JÄRGI, VÕIB TULEMUSEKS OLLA TÕSINE KEHAVIGASTUS VÕI SURM.

LUGEGE ENNE KASUTAMIST VÄIKELAPSE TURVATOOLI OHUTUSJUHENDIT THULE ELM JA HOIDKE SEDA EDASPIDISEKS KASUTAMISEKS.

SEE TOODE EI PRUUGI HEAKSKIIDETUD SÕIDUKIS SOBIDA KÕIKIDESSE LAMAVATESSE ASENDITESSE.

LV

SVARĪGI - PIRMS LIETOŠANAS UZMANĪGI IZLASIET ŠO INSTRUKCIJU. JA NIEIVĒROSĪET ŠOS NORĀDĪJUMUS. VAR RASTIES NOPIETNI IEVAINOJUMI VAI IESTĀTIES NĀVE.

PIRMS LIETOŠANAS IZLASIET THULE ELM MAZULĀ AUTOSĒDEKLĪŠA DROŠĪBAS ROKASGRĀMATU UN SAGLABĀJĪET TO TURPMĀKAI IZMANTOŠANAI.

IR IESPĒJAMS, KA ŠO IZSTRĀDĀJUMU VISŠS TĀ SLĪPUMA POZĪCIJĀS NEVAR IEVIETOT APSTIPRINĀTĀ TRANSPORTLĪDZEKLĪ.

LT

SVARBU - PRIEŠ NAUDOJANT ATIDŽIAI PERSKAITYTI INSTRUKCIJAS IR IŠSAUGOTI JAS, KAD BŪTŲ GALIMA VADOVAUTIS IR VĒLIAU. ŠIŲ NURODYMŲ NESILAIKYMAS GALI LEMTI MIRTĮ ARBA SUNKIUS SUŽALOJIMUS.

PRIEŠ NAUDODAMI PERSKAITYKITE MAŽYLIO AUTOMOBILINĖS THULE ELM KĖDUTĖS SAUGOS VADOVĄ IR PASILIKITE ATEIČIAI.

ŠIS PRODUKTAS PATVIRTINTOJE TRANSPORTO PRIEMONĖJE GALI TIKTI NE VISOMS ATLOŠO ATLENKIMO PADĖTIMS.

UK

ВАЖЛИВО - ЗБЕРІГАЙТЕ ЦІ ІНСТРУКЦІЇ ДЛЯ ПОДАЛЬШОЇ ДОВІДКИ. ЯКЩО НЕ ДОТРИМУВАТИСЯ ЦИХ ІНСТРУКЦІЙ, ЦЕ МОЖЕ ПРИЗВЕСТИ ДО СМЕРТІ АБО СЕРІОЗНИХ ТРАВМ.

ПЕРЕД ЗАСТОСУВАННЯМ ПЕРЕГЛЯНЬТЕ ПОСІБНИК ІЗ БЕЗПЕКИ ДЛЯ ДИТЯЧОГО АВТОКРІСЛА THULE ELM ТА ЗБЕРІГАЙТЕ ЙОГО ДЛЯ ВИКОРИСТАННЯ В МАЙБУТЬОМУ.

ЦЕЙ ПРОДУКТ МОЖЕ НЕ ВМИЩАТИСЯ У ВСІ ПОЛОЖЕННЯ СХИЛЕННЯ У СХВАЛЕНОМУ ТРАНСПОРТНОМУ ЗАСОБІ.

PL

WAŻNE - PRZED UŻYTKOWANIEM DOKŁADNIE PRZECZYTAĆ NINIEJSZĄ INSTRUKCJĘ I ZACHOWAĆ JĄ NA PRZYSZŁOŚĆ. NIEPRZESTRZEGANIE TEGO ZAKAZU MOŻE DOPROWADZIĆ DO POWAŻNYCH OBRAŻEŃ LUB ŚMIERCI.

PRZED ROZPOCZĘCIEM UŻYTKOWANIA FOTELIKA SAMOCHODOWEGO DLA MAŁYCH DZIECI THULE ELM PRZECZYTAJ INSTRUKCJĘ OBSŁUGI I ZACHOWAJ DO WYKORZYSTANIA W PRZYSZŁOŚCI.

MOŻE OKAZAĆ SIĘ, ŻE KORZYSTANIE Z NIEKTÓRYCH POZYCJI ODCHYLENYCH PRODUKTU W KOMPATYBILNYM POJEŹDZIE JEST NIEMOŻLIWE.

CS

DŮLEŽITÉ - PŘED POUŽITÍM SI PŘEČTĚTE POZORNĚ NÁVOD A USCHOVEJTE PRO POZDĚJŠÍ NAHLÉDNUTÍ. PŘI NEDODRŽENÍ TĚCHTO POKYNŮ HROZÍ RIZIKO USMRČENÍ NEBO VÁŽNÉHO ZRANĚNÍ.

PŘED POUŽITÍM SI PŘEČTĚTE BEZPEČNOSTNÍ PŘÍRUČKU K AUTOSEDAČCE THULE ELM PRO BATOLE A USCHOVEJTE JI PRO BUDOUCÍ POUŽITÍ.

TENTO PRODUKT SE NEMUSÍ VEJÍT DO SCHVÁLENÉHO VOZIDLA VE VŠECH POLOHÁCH SKLONU.

FONTOS - HASZNÁLAT ELŐTT FIGYELMESEN OLVASSA EL AZ UTASÍTÁSOKAT ÉS ŐRIZZE MEG A JÓVÓBENI HIVATKOZÁSHOZ. HALÁL VAGY SÚLYOS SÉRÜLÉS FORDULHAT ELŐ, HA NEM KÖVETI EZEKET AZ UTASÍTÁSOKAT.

HASZNÁLAT ELŐTT OLVASSA EL A THULE ELM AUTÓS GYEREKÜLÉS BIZTONSÁGI KÉZIKÖNYVÉT, ÉS ŐRIZZE MEG KÉSŐBBI FELHASZNÁLÁS CÉLJÁBÓL.

EZ A TERMÉK NEM BIZTOS, HOGY MINDEN DÖLÉSSZÖGBEN ELFÉR EGY JÓVÁHAGYOTT JÁRMŰBEN.

IMPORTANT - PĂSTRAȚI ACESTE INSTRUCȚIUNI PENTRU CONSULTARE ULTERIOARĂ. NERESPECTAREA ACESTOR INSTRUCȚIUNI SE POATE SOLDA CU VĂTĂMAREA GRAVĂ SAU DECESUL COPILULUI.

CITIȚI MANUALUL PRIVIND SIGURANȚA SCAUNULUI AUTO PENTRU COPII THULE ELM ÎNAINTE DE A-L UTILIZA ȘI PĂSTRAȚI-L PENTRU CONSULTAREA SA ULTERIOARĂ.

ACEST PRODUS S-AR PUTEA SĂ NU SE POTRIVEASCĂ ÎN TOATE POZIȚIILE DE ÎNCLINARE ÎNTR-UN VEHICUL APROBAT.

DÔLEŽITÉ - PRED POUŽITÍM PREČÍTAJTE POZORNE TENTO NÁVOD A USCHOVAJTE HO PRE BUDÚCU POTREBU. AK TIETO POKYNY NEDODRŽÍTE, MÔŽE DÔJSŤ K VÁŽNEMU ZRANENIU ALEBO SMRTI.

PRED POUŽITÍM SI PREČÍTAJTE BEZPEČNOSTNÚ PRÍRUČKU PRE AUTOSEDAČKU PRE BATOLATÁ THULE ELM A USCHOVAJTE SI JU PRE BUDÚCE POUŽITIE.

TENTO PRODUKT SA NEMUSÍ ZMESTIŤ DO VŠETKYCH POLÔH SKLONU V SCHVÁLENOM VOZIDLE.

POMEMBNO - PRED UPORABO POZORNO PREBERITE NAVODILA IN JIH SHRANITE KOT NAPOTEK ZA V PRIHODNJE. ČE NE UPOŠTEVATE TEH NAVODIL, LAHKO PRIDE DO SMRTI ALI HUDIH TELESNIH POŠKODB.

PRED UPORABO PREBERITE VARNOSTNA NAVODILA ZA OTROŠKI AVTOMOBILSKI SEDEŽ THULE ELM IN JIH SHRANITE ZA NADALJNJO UPORABO.

TA IZDELEK MORDA NE USTREZA VSEM POLOŽAJEM NAGIBA V ODOBRENEM VOZILU.

ВАЖНО - ЗАПАЗЕТЕ ТЕЗИ ИНСТРУКЦИИ ЗА БЪДЕЩИ СПРАВКИ. АКО НЕ СЛЕДВАТЕ ТЕЗИ ИНСТРУКЦИИ, МОЖЕ ДА НАСТЪПИ СМЪРТ ИЛИ СЕРИОЗНО НАРАНЯВАНЕ.

ПРОЧЕТЕТЕ РЪКОВОДСТВОТО ЗА БЕЗОПАСНОСТ ЗА ДЕТСКОТО СТОЛЧЕ ЗА КОЛА THULE ELM ПРЕДИ УПОТРЕБА И ЗАПАЗЕТЕ ЗА БЪДЕЩА СПРАВКА.

ТОЗИ ПРОДУКТ МОЖЕ ДА НЕ ПАСНЕ ВЪВ ВСИЧКИ ЛЕГНАЛИ ПОЛОЖЕНИЯ В ОДОБРЕНО ПРЕВОЗНО СРЕДСТВО.

VAŽNO - SAČUVAJTE OVE UPUTE ZA BUDUĆU UPORABU. AKO NE SLIJEDITE OVE UPUTE MOŽE DOĆI DO SMRTI ILI OZBILJNE OZLJEDE.

PROČITAJTE PRIRUČNIK O THULE ELM SIGURNOSTI ZA DJEČJU AUTOSJEDALICU PRIJE UPORABE I SAČUVAJTE GA ZA BUDUĆU UPORABU.

OVAJ PROIZVOD MOŽDA NEĆE PRISTAJATI U SVIM POLOŽAJIMA NAGIBA U ODOBRENOM VOZILU.

ΣΗΜΑΝΤΙΚΟ - ΦΥΛΑΞΤΕ ΑΥΤΕΣ ΤΙΣ ΟΔΗΓΙΕΣ ΓΙΑ ΜΕΛΛΟΝΤΙΚΗ ΑΝΑΦΟΡΑ. ΘΑΝΑΤΟΣ Η ΣΟΒΑΡΟΣ ΤΡΑΥΜΑΤΙΣΜΟΣ ΜΠΟΡΕΙ ΝΑ ΣΥΜΒΕΙ ΕΑΝ ΔΕΝ ΑΚΟΛΟΥΘΗΣΕΤΕ ΑΥΤΕΣ ΤΙΣ ΟΔΗΓΙΕΣ.

ΔΙΑΒΑΣΤΕ ΤΟ ΕΓΧΕΙΡΙΔΙΟ ΑΣΦΑΛΕΙΑΣ ΓΙΑ ΤΟ ΝΗΠΙΑΚΟ ΚΑΘΙΣΜΑ ΑΥΤΟΚΙΝΗΤΟΥ THULE ELM ΠΡΙΝ ΑΠΟ ΤΗ ΧΡΗΣΗ ΚΑΙ ΦΥΛΑΞΤΕ ΤΟ ΓΙΑ ΜΕΛΛΟΝΤΙΚΗ ΑΝΑΦΟΡΑ.

ΑΥΤΟ ΤΟ ΠΡΟΪΟΝ ΕΝΔΕΧΕΤΑΙ ΝΑ ΜΗΝ ΤΑΙΡΙΑΖΕΙ ΣΕ ΟΛΕΣ ΤΙΣ ΘΕΣΕΙΣ ΑΝΑΚΛΙΣΗΣ ΣΕ ΕΝΑ ΕΓΚΕΚΡΙΜΕΝΟ ΟΧΗΜΑ.

ÖNEMLİ - BU TALIMATLARI İLERİDE BAŞVURMAK ÜZERE SAKLAYIN. BU TALIMATLARA UYMAMANIZ HALİNDE ÖLÜM VEYA CİDDİ YARALANMALAR MEYDANA GELEBİLİR.

KULLANMADAN ÖNCE YÜRÜMEYE BAŞLAYAN ÇOCUK OTU KOLTUĞU İÇİN THULE ELM GÜVENLİK KILAVUZUNU OKUYUN VE İLERİDE BAŞVURMAK ÜZERE SAKLAYIN.

BU ÜRÜN ONAYLI BİR ARAÇTAKI TÜM YATIRMA POZİSYONLARINA SİĞMAYABİLİR.

هام - احتفظ بهذه الإرشادات للرجوع إليها في المستقبل. يمكن أن تحدث وفاة أو إصابة خطيرة إذا لم يتم اتباع هذه الإرشادات.

اقرأ دليل السلامة لمقعد THULE ELM السيارة للأطفال الصغار قبل الاستخدام واحتفظ به للرجوع إليه في المستقبل.

قد لا يتناسب هذا المنتج في جميع وضعيات الاستلقاء في مركبة معتمدة.



Congratulations!

And thank you for choosing Thule Elm! You can rest assured that we have put all our efforts, knowledge and passion into designing the most safe, reliable and easy to use toddler car seat, we could think of.

Visual language



WARNING indicates a hazardous situation which, if not avoided, could result in death or serious injury.



Visual check ok



NOTE indicates additional information that is useful for trouble-free and optimal use of the product.



Visual check wrong



Audible click

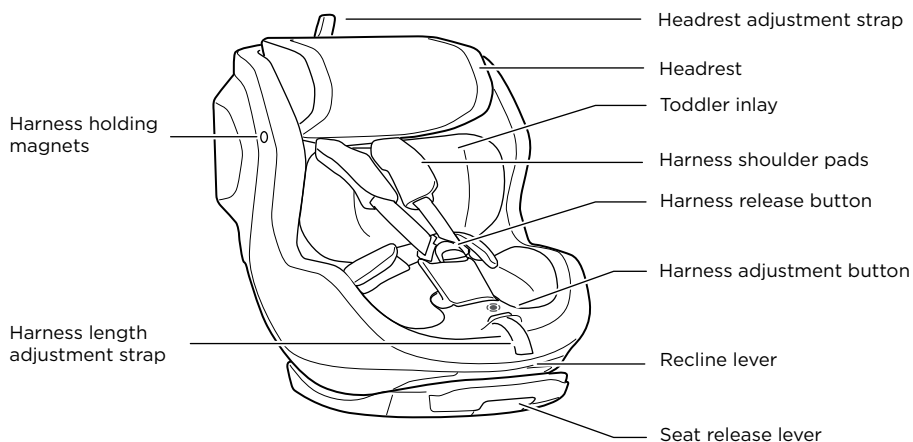

Click on this button
to go to the main menu.

Félicitations!

Nous vous remercions d'avoir choisi Thule Elm ! Soyez certain que nous avons consacré notre énergie, nos connaissances et notre passion à la conception du siège auto pour enfant le plus sécurisé, fiable et facile à utiliser possible.

Symboles



AVERTISSEMENT indique une situation potentiellement dangereuse qui, si elle n'est pas évitée, pourrait provoquer des blessures graves, voire mortelles.



REMARQUE indique comment répondre à une situation donnée et vous donnent des conseils sur le fonctionnement des options disponibles.



Contrôle visuel ok



Contrôle visuel mauvaise



Clic audible

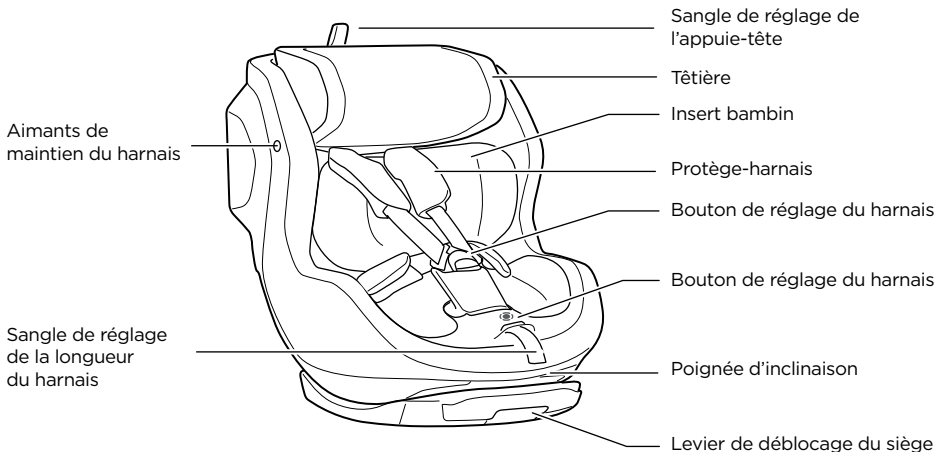

Cliquez sur ce bouton pour accéder au menu principal

Enhorabuena

¡Gracias por elegir Thule Elm! Tenga la seguridad de que hemos dedicado todos nuestros esfuerzos, conocimientos y pasión al diseño de la silla de automóvil para niños pequeños más segura, fiable y fácil de usar imaginable.

Lenguaje visual



ADVERTENCIA Indica una situación de posible peligro que, si no se evita, podría provocar lesiones graves o incluso la muerte.



NOTA Indica información adicional que es útil para un uso óptimo y sin problemas del producto.



Comprobación visual - ok



Comprobación visual - incorrecta

Click Clic audible

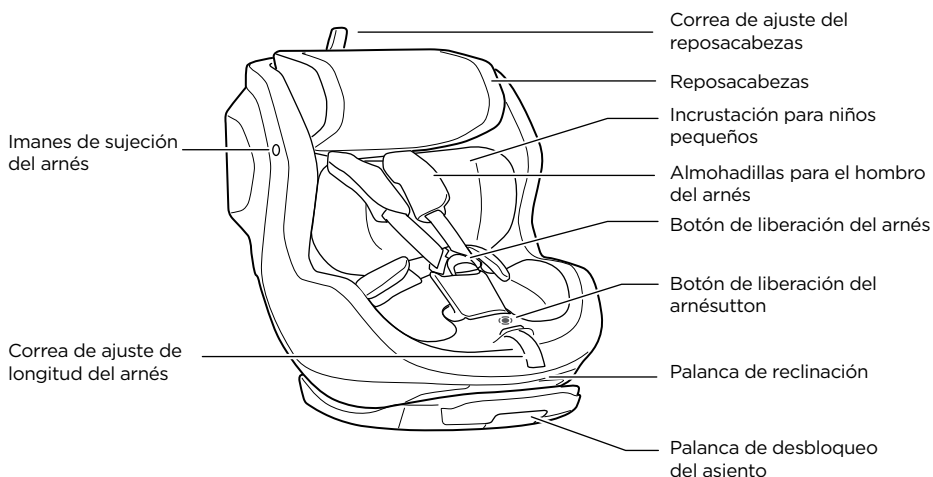

Haga clic en este botón para ir al menú principal

Herzlichen Glückwunsch!

Und vielen Dank, dass du Dich für den Thule Elm entschieden hast! Du kannst Dich darauf verlassen, dass wir all unsere Anstrengungen, unser Wissen und unsere Leidenschaft eingesetzt haben, um den sichersten, zuverlässigsten und benutzerfreundlichsten Kleinkindersitz zu entwickeln, den man sich vorstellen kann.

Bildsprache



WARNUNG Eine mögliche Gefahrsituation, die, wenn sie nicht vermieden wird, zum Tod oder zu ernsthaften Verletzungen führen kann.



HINWEIS Eine zusätzliche Information, die für eine problemlose und optimale Verwendung des Produkts nützlich ist.



Sichtprüfung i. O.



Sichtprüfung nicht i. O.



Hörbares Klicken

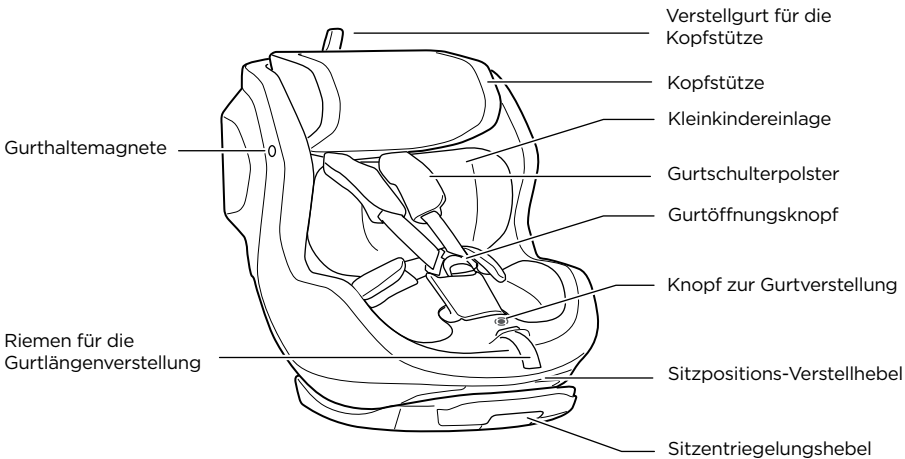

Mit einem Klick auf diese Schaltfläche gelangst Du zum Hauptmenü

Gefeliciteerd

En bedankt dat u hebt gekozen voor de Thule Elm!

U kunt ervan verzekerd zijn dat we al onze inspanningen, kennis en passie hebben gestopt in het ontwerpen van het meest veilige, betrouwbare en gebruiksvriendelijke autostoeltje voor kinderen dat we maar konden bedenken.

Bildsprache



WAARSCHUWING duidt op een gevaarlijke situatie die, indien deze niet wordt vermeden, de dood of ernstig letsel tot gevolg kan hebben.



OPMERKING geeft aanvullende informatie aan die nuttig is voor een probleemloos en optimaal gebruik van het product.



Visuele controle - ok



Visuele controle - fout



Hoorbare klik

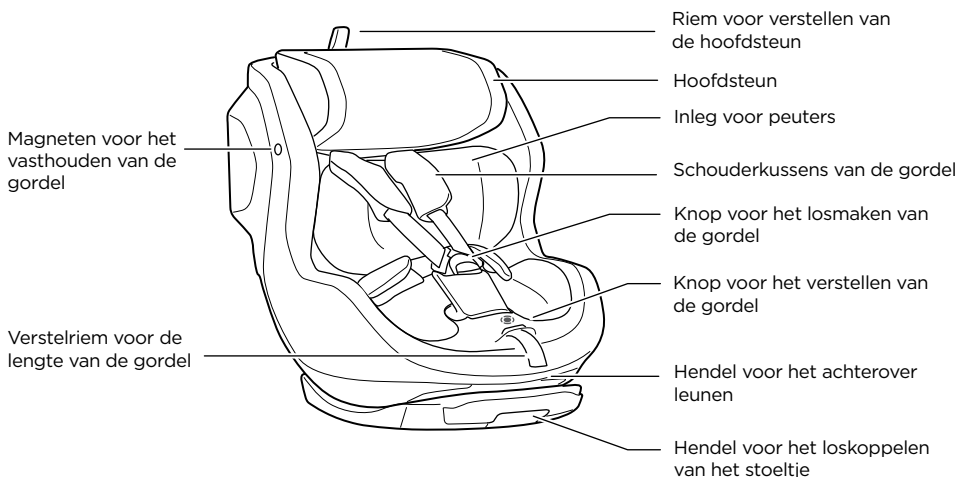

Klik op deze knop om naar het hoofdmenu te gaan

Parabéns

Obrigado por escolher o Thule Elm! Pode ficar descansado na certeza de que envidámos os nossos melhores esforços, conhecimento e paixão na concepção do assento automóvel para crianças mais crescidas mais seguro, fiável e fácil de utilizar que conseguimos imaginar.

Informações visuais



ATENÇÃO indica uma situação perigosa que, se não for evitada, pode resultar em morte ou ferimentos graves.



NOTA indica informações adicionais que são úteis para a utilização ideal e sem problemas do produto.



Verificação visual - ok



Verificação visual - errado

Click Clique audível

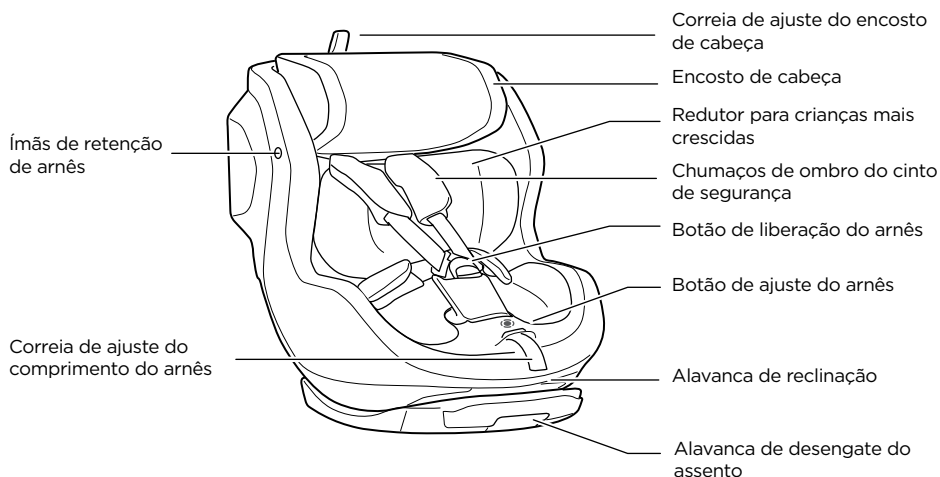

Clique neste botão para ir para o menu principal

Congratulazioni

Grazie per aver scelto Thule Elm! Abbiamo riposto tutto il nostro impegno, la nostra passione e le nostre conoscenze nella progettazione del seggiolino auto per bambini più sicuro, affidabile e facile da utilizzare.

Linguaggio visivo



AVVERTIMENTO indica una situazione pericolosa che, se non evitata, potrebbe causare la morte o gravi lesioni.



NOTA indica informazioni aggiuntive utili per un utilizzo senza problemi e ottimali del prodotto.



Controllo visivo - ok



Controllo visivo - sbagliato



Clic percettibile

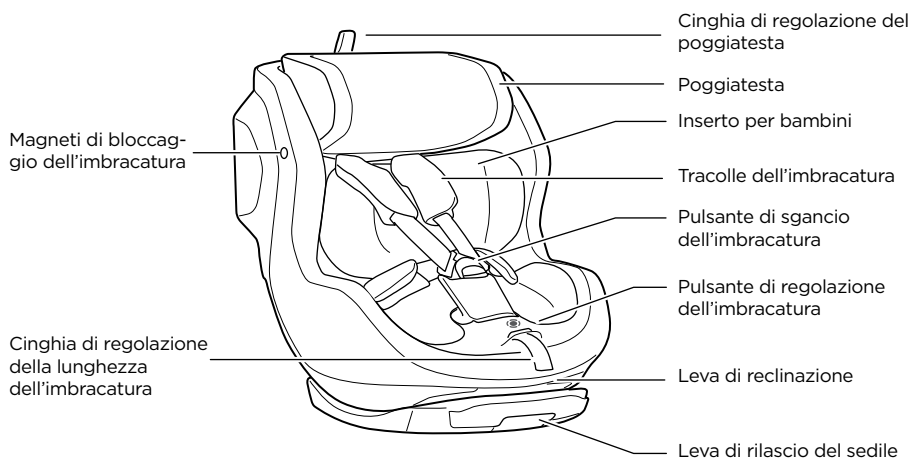

Fare clic su questo pulsante per andare al menu principale

Grattis

Och tack för att du valde Thule Elm! Du kan vara säker på att vi har lagt alla våra ansträngningar, kunskap och passion på att utforma den mest säkra, pålitliga och lättanvända bilbarnstol för småbarn vi kan tänka oss.

Visuella instruktioner



VARNING indikerar en potentiellt farlig situation som, om den inte undviks, kan leda till dödsfall eller allvarlig personskada.



OBS! Indikerar ytterligare information som är användbar för problemfri och optimal användning av produkten.



Visuell kontroll - ok



Visuell kontroll - felaktig

Click Hörbart klick

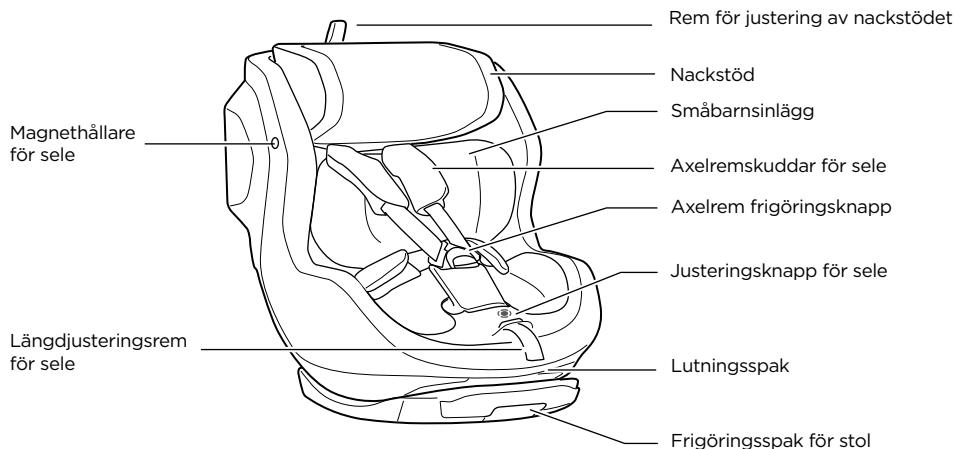

Klicka på den här knappen för att gå till huvudmenyn

Tillykke

Og tak, fordi du valgte Thule Elm! Du kan være sikker på, at vi har lagt alle vores kræfter, viden og passion i at designe den mest sikre, pålidelige og brugervenlige autostol til småbørn, vi kunne komme i tanke om.

Visualiser sprog



ADVARSEL angiver en potentielt farlig situation, som, hvis den ikke undgås, kan føre til død eller alvorlig skade.



BEMÆRK angiver yderligere information, der er nyttig for problemfri og optimal brug af produktet.



Visuelt tjek - ok



Visuelt tjek - forkert

Click Hørbart klik

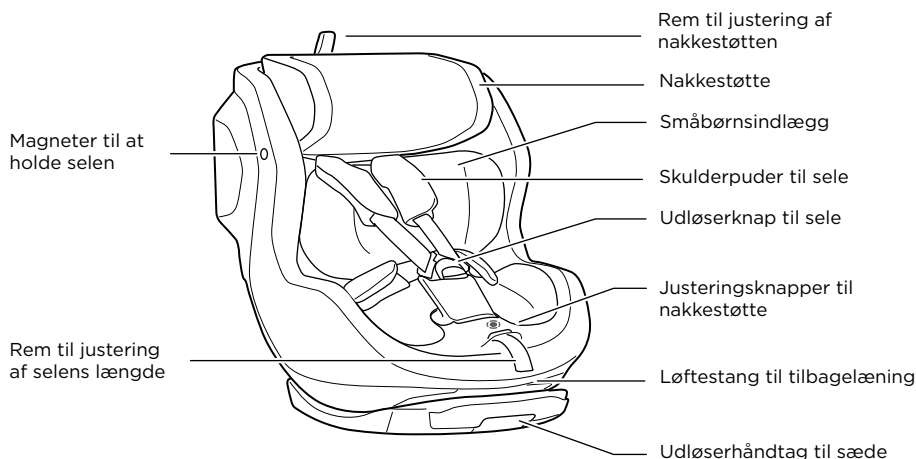

Klik på denne knap for at gå til hovedmenuen

Gratulerer

Og takk for at du valgte Thule Elm. Du kan være trygg på at vi har lagt all vår erfaring, kunnskap og lidenskap i å utvikle det sikreste, mest pålitelige og mest brukervennlige bilstolen for småbarn vi kan tenke oss.

Symboler



ADVARSEL indikerer en potensielt farlig situasjon som, hvis den ikke unngås, kan føre til død eller alvorlig personskade.



MERK indikerer tilleggsinformasjon som er nyttig for problemfri og optimal bruk av produktet.



Visuell sjekk - ok



Visuell sjekk - ikke ok

Click Hørbart klikk

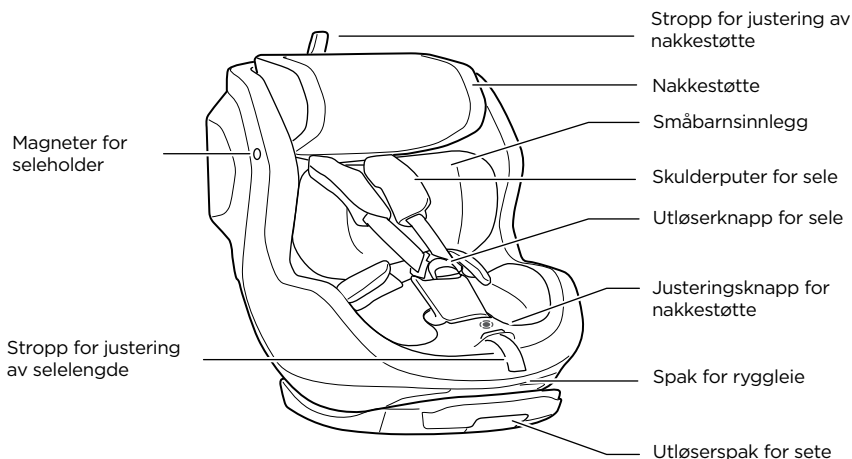

Klikk på denne knapp for at gå til hovedmenyen

Onnittelut

Kiitos, että valitsit Thule Elmin! Olemme laittaneet kaiken osaamisemme peliin ja kehittäneet vaivoja säästämättä mahdollisimman turvallisen, luotettavan ja helppokäyttöisen taaperon turvaistuimen.

Visuaalinen kieli



VAROITUS viittaa vaaratilanteeseen, joka voi - jos sitä ei vältetä - johtaa kuolemaan tai vakavaan loukkaantumiseen.



HUOMAUTUS viittaa lisätietoihin, joista on hyötyä tuotteen ongelmattoman ja optimaalisen käytön kannalta.



Silmämääräinen tarkistus - kunnossa



Silmämääräinen tarkistus - väärin



Kuultavissa oleva napsahdus

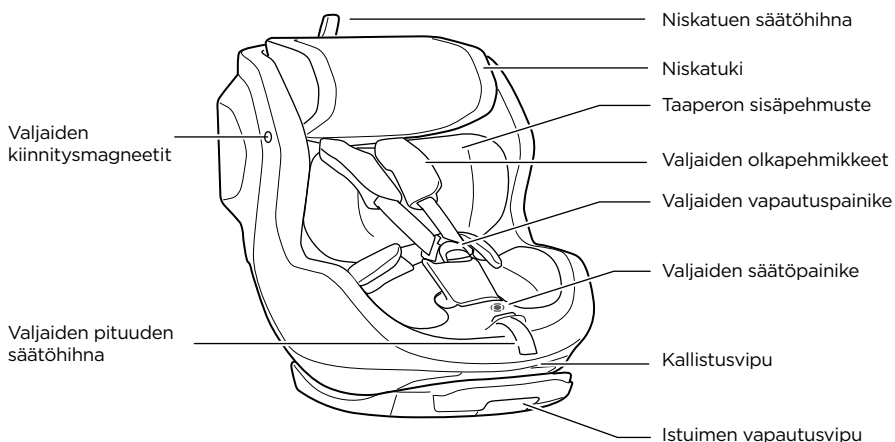

Siirry päävalikkoon napsauttamalla tätä painiketta

Til hamingju

Og takk fyrir að velja Thule Elm! Þú getur treyst því að við höfum lagt alla okkar vinnu, þekkingu og ástríðu í að hanna öruggasta, áreiðanlegasta og aðgengilegasta smábarnabílstólinn sem okkur kom til hugar.

Tungumál



VIÐVÖRUN gefur til kynna hættulegar aðstæður sem geta valdið dauða eða alvarlegum meiðslum ef ekki er í komið í veg fyrir þær.



ATHUGIÐ gefur til kynna viðbótarupplýsingar sem koma að gagni við að tryggja hnökralausa og hagnýta notkun vörunnar.



Sjónræn skoðun - í lagi



Sjónræn skoðun - ekki í lagi

Click

Smellur heyrst

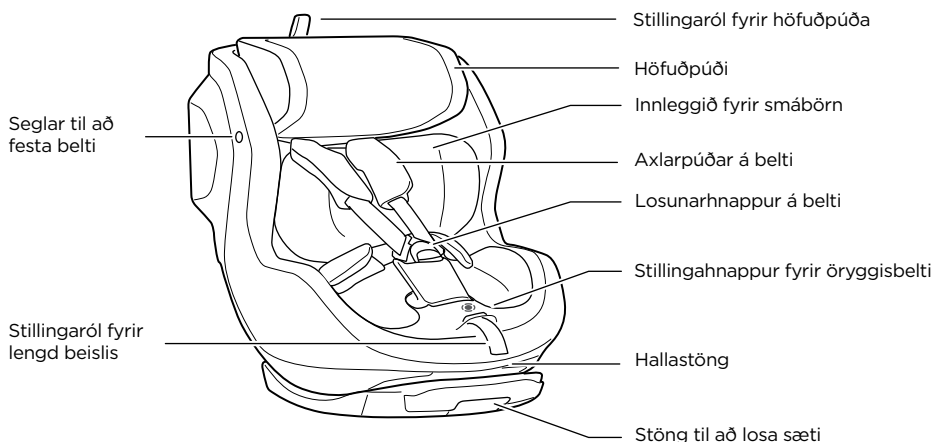

Smelltu á þennan hnapp til að fara í aðalvalmyndina

Õnnitleme

Täname, et valisite toote Thule Elm. Võite kindel olla, et oleme loonud kõige paindlikuma ja turvalisema vankrikorvi tehes seda maksimaalse püüdluse ja inspiratsiooniga.

Visuaalne keel



HOIATUS tähistab ohtlikku olukorda ja kui seda ei õnnestu vältida, võib see lõppeda surma või kehavigastusega.



MÄRKUS tähistab lisateavet, mida on vaja toote muretu ja optimaalse kasutamise jaoks.



Visuaalne kontroll - ok



Visuaalne kontroll - ebaõnnestus

Click Kuuldav klõpsatus

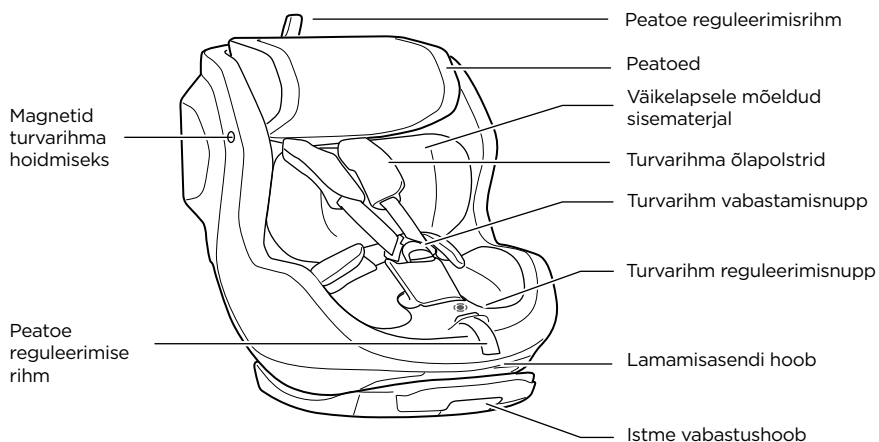

Peamenüüsse liikumiseks klõpsake sellel nupul

Apsveicam

Paldies, ka izvēlējāties Thule Elm! Varat būt droši, ka mēs esam darījuši visu iespējamo, izmantojuši savas zināšanas un aizrautību, izgatavojot drošāko, uzticamāko un vienkāršāk lietojamo mazuļa autosēdekli, kādu vien varējām iedomāties.

Vizuālie apzīmējumi



BRĪDINĀJUMS norāda uz bīstamu situāciju, kas var izraisīt nāvi vai nopietnu traumu, ja tā netiek novērsta.



PIEZĪME sniedz papildinformāciju, kas ir noderīga netraucētai un optimālai produkta lietošanai.



Vizuālā pārbaude - ok



Vizuālā pārbaude - nepareizi

click Dzirdams klikšķis

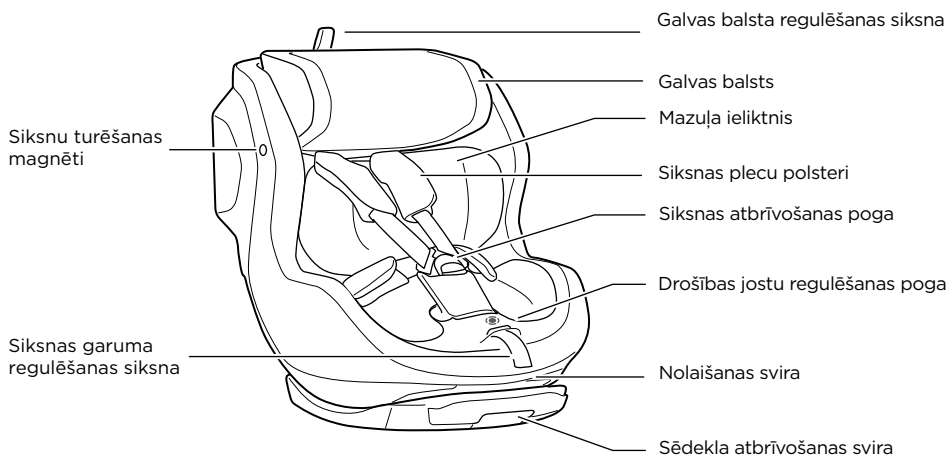

Noklikšķiniet uz šīs pogas, lai pārietu uz galveno izvēlni

Sveikiname

Dėkojame, kad pasirinkote Thule Elm! Užtikriname, jog dėjome visas pastangas, pasitelkėme visas žinias ir entuziazmą, kad sukurtume saugiausią, patikimiausią ir lengviausią naudoti ISOFIX pagrindą, koks tik gali būti.

Matoma kalba



ĮSPĖJIMAS nurodoma pavojinga situacija, kurios neišvengus galima žūti arba patirti rimtų sužeidimų.



PASTABA nurodoma papildoma informacija, naudinga norint gaminį eksploatuoti be problemų ir optimaliai naudoti.



Vizualinė patikra - teisinga



Vizualinis patikrinimas - neteisingas

Click Spragtelėjimas

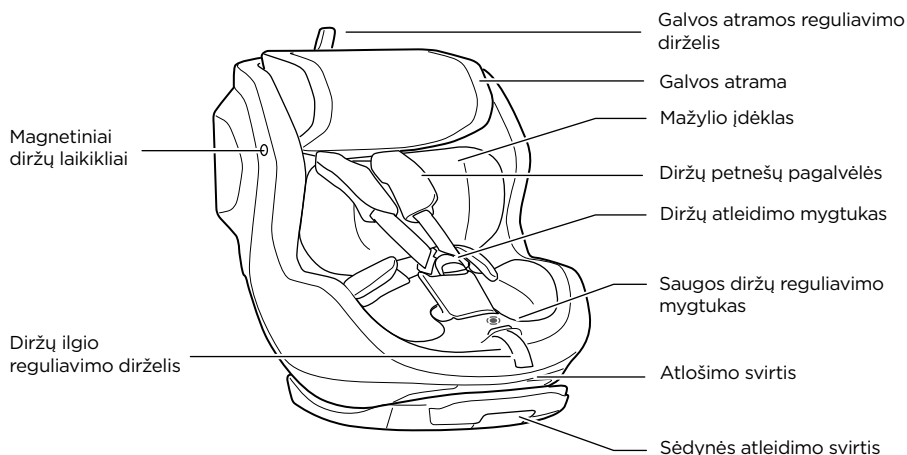

Spustelėkite šį mygtuką, kad pereitumėte į pagrindinį meniu

Вітаємо

Дякуємо, що обрали Thule Elm! Запевняємо вас, що ми доклали всіх зусиль, знань та ентузіазму, щоб розробити найбільш безпечно, надійне й просте у використанні дитяче автокрісло, яке тільки можна уявити.

Мова візуального спілкування



ПОПЕРЕДЖЕННЯ вказує на небезпечну ситуацію, яка, якщо її не уникнути, може призвести до смерті або серйозних травм.



ПРИМІТКА вказує на додаткову інформацію, корисну для безперебійного та оптимального використання виробу.



Візуальна перевірка - правильно



Візуальна перевірка - невірно

click Чутне клацання

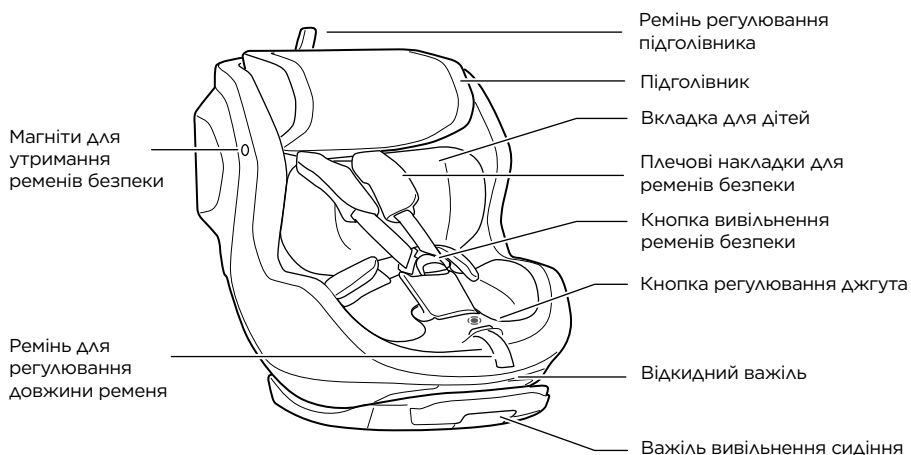

Натисніть на цю кнопку, щоб перейти в головне меню

Gratulujemy

Dziękujemy za wybór fotelika Thule Elm! Mogą Państwo być pewni, że dołożyliśmy wszelkich starań i wykorzystaliśmy całą naszą wiedzę i pasję przy projektowaniu tego najbardziej bezpiecznego, niezawodnego i łatwego w obsłudze fotelika samochodowego dla małych dzieci, jaki można sobie wyobrazić. Wszystko po to, aby mogli Państwo ze swoim dzieckiem pójść gdziekolwiek tylko zechcą.

Piktogramy



OSTRZEŻENIE wskazuje potencjalnie niebezpieczną sytuację, która może, jeśli się jej nie uniknie, spowodować poważne obrażenia lub nawet śmierć.



UWAGA oznacza dodatkowe informacje, z których warto korzystać, aby bezproblemowo i optymalnie użytkować produkt.



Sprawdzenie wizualne — ok



Sprawdzenie wizualne — Nieprawidłowa



Słyszalne kliknięcie

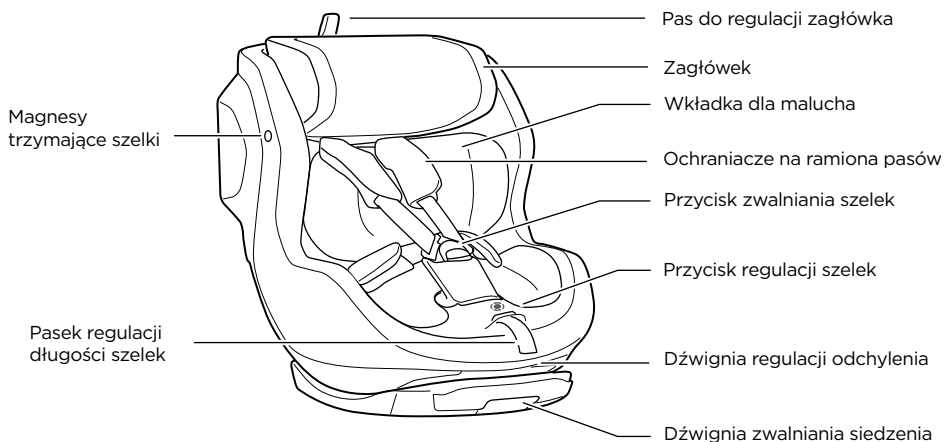

Kliknij ten przycisk, aby przejść do menu głównego

Blahopřejeme

A děkujeme, že jste se rozhodli pro výrobek Thule Elm. Můžete si být jisti, že jsme vložili veškeré naše úsilí, znalosti a vášně do vytvoření maximálně bezpečné, spolehlivé a snadno použitelné autosedačky pro batole, jakou si jen dovedete představit.

Vizuální jazyk



VAROVÁNÍ značí nebezpečnou situaci, která může, pokud se jí nevyhnete, vést ke smrti nebo vážnému zranění.



POZNÁMKA značí dodatečné informace, které jsou užitečné pro bezproblémové a optimální používání produktu.



Vizuální kontrola - ok



Vizuální kontrola - špatná



Hlasité zaklapnutí

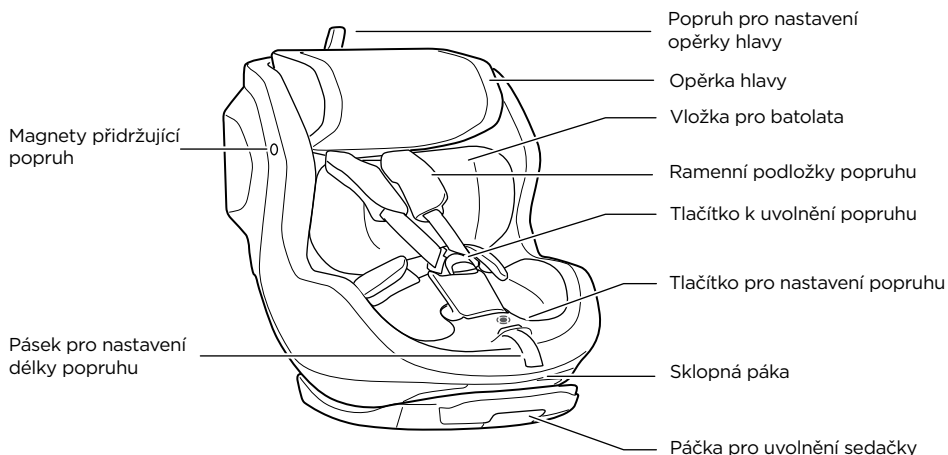

Kliknutím na toto tlačítko přejdete do hlavního menu

Gratulálunk

És köszönjük, hogy a Thule Elm terméket választotta! Biztos lehet benne, hogy minden tudásunkat, szenvedélyünket és erőfeszítésünket beleadtuk az elképzelhető legbiztonságosabb, legmegbízhatóbb és legkönnyebben használható autós gyerekülés megtervezésébe.

Vizuális jelzések



FIGYELMEZTETÉS olyan veszélyes helyzetet jelez, amely, ha nem kerüljük el, halálhoz vagy súlyos sérüléshez vezethet.



MEGJEGYZÉS a termék problémamentes és optimális használatához hasznos kiegészítő információkat jelöl.



Szemrevételezés - rendben



Szemrevételezés - helytelen

Click Hallható kattanas

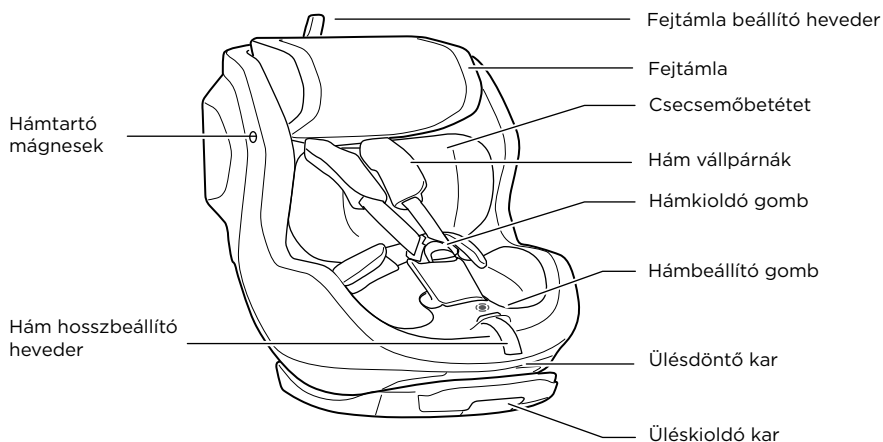

Kattintson erre a gombra a főmenübe lépéshez

Felicitări

Mulțumim că ați ales Thule Elm! Puteți avea certitudinea că am depus toate eforturile, ne-am utilizat toate cunoștințele și am investit toată pasiunea în proiectarea celui mai sigur, de încredere și ușor de folosit scaun auto pentru copii pe care ni l-am putut imagina.

Limbajul vizual



AVERTISMENT indică o situație periculoasă care, dacă nu este evitată, poate provoca răniri grave sau deces.



NOTĂ indică informații suplimentare, care sunt folosite pentru utilizarea fără probleme și optimă a produsului.



Inspecție vizuală - ok



Inspecție vizuală - incorectă

Click Sunet de clic audibil

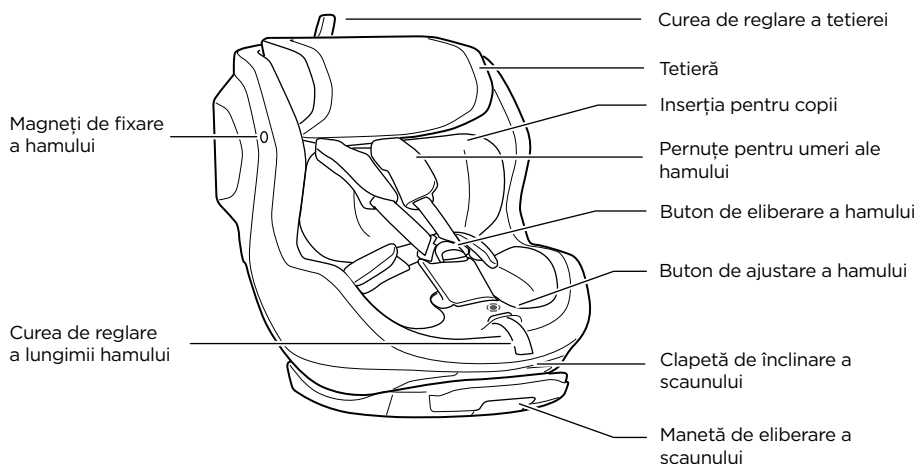

Faceți clic pe acest buton pentru a accesa meniul principal

Gratulujeme

A ďakujeme, že ste sa rozhodli pre výrobok Thule Elm! Do navrhovania tej najbezpečnejšej a najspoľahlivejšej autosedačky pre batolátá, ktorá sa jednoducho používa, sme vložili všetko naše úsilie, vedomosti a vášeň.

Vizuálny jazyk



VAROVANIE označuje nebezpečnú situáciu, ktorá môže mať za následok smrť alebo vážne zranenie, ak sa jej nezabráni.



POZNÁMKA označuje dodatočné informácie, ktoré sú užitočné pre bezpečné a optimálne používanie výrobku.



Vizuálna kontrola - dobrá



Vizuálna kontrola - zlá



Počuteľné kliknutie

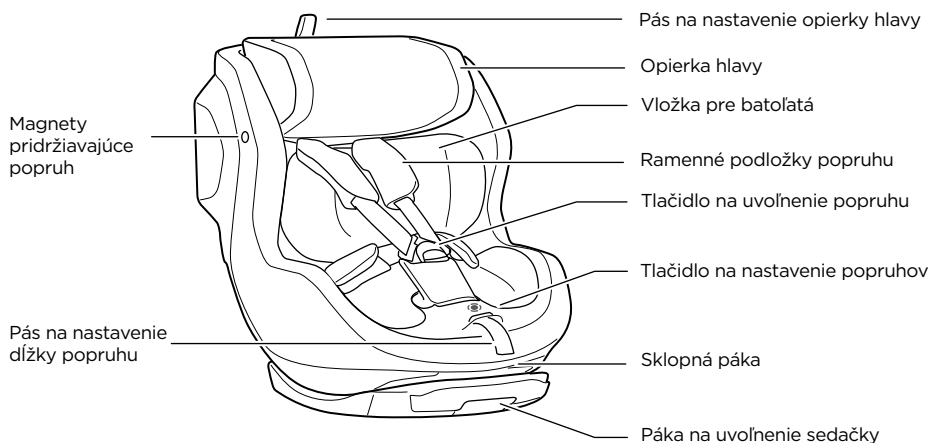

Kliknutím na toto tlačidlo prejdete do hlavnej ponuky

Čestitamo

Hvala, da ste izbrali Thule Elm! Zagotavljamo vam, da smo vložili ves svoj trud, znanje in strast v oblikovanje najvarnejšega in najbolj zanesljivega avtomobilskega sedeža za otroke, ki je enostaven za uporabo.

Oznake



OPOZORILO označuje nevarno situacijo, ki lahko povzroči smrt ali hude poškodbe, če se ji ne izognete.



OPOMBA označuje dodatne informacije, ki so koristne za nemoteno in optimalno uporabo izdelka.



Vizualna kontrola - v redu



Vizualna kontrola - napačno

Click Slišen klik

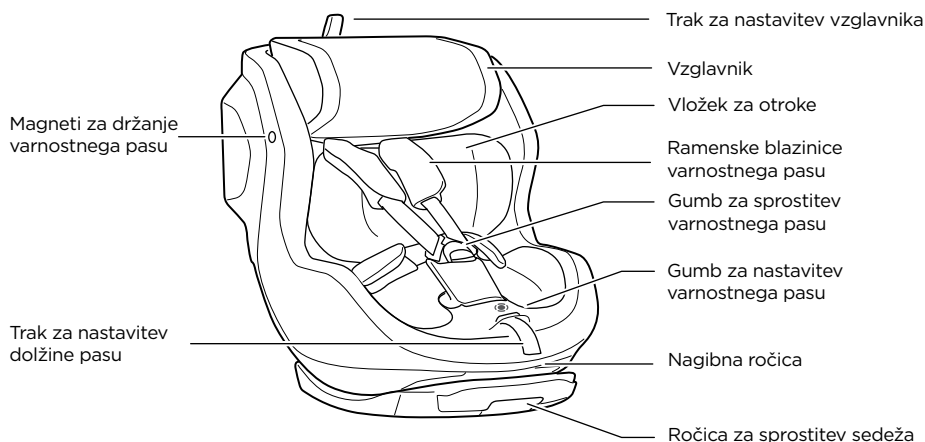

Kliknite ta gumb za glavni meni

Поздравления

И ви благодарим, че избрахте Thule Elm! Можете са сте сигурни, че сме вложили всички усилия, познания и страст в проектирането на най-безопасното, надеждно и лесно за употреба детско столче за кола, което можахме да измислим.

Визуален език



ПРЕДУПРЕЖДЕНИЕ показва опасна ситуация, която, ако не бъде избегната, може да доведе до смърт или сериозно нараняване.



ЗАБЕЛЕЖКА показва допълнителна информация, която е полезна за безпроблемно и оптимално използване на продукта.



Визуалната проверка - правилна



Визуалната проверка - неправилна

Click Звуково щракване

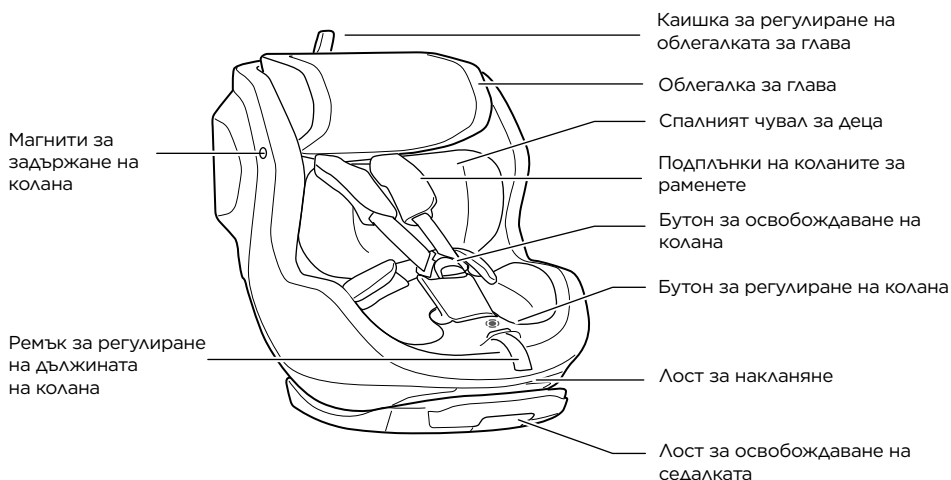

Кликнете върху този бутон, за да отидете в главното меню

Čestitamo

Hvala vam što ste izabrali proizvod Thule Elm! Budite sigurni da smo se doista potrudili i uložili znanje i strast u dizajniranje najsigurnijih, najpouzdanijih i jednostavnih autosjedalica za malu djecu.

Vizualan jezik



UPOZORENJE označava opasnu situaciju koja, ako se ne izbjegne, može uzrokovati smrt ili ozbiljnu povredu.



NAPOMENA naznačuje dodatne informacije korisne za neometanu i optimalnu upotrebu proizvoda.



Vizualna provjera - ok



Vizualna provjera - nije ok

Click Zvučni klik

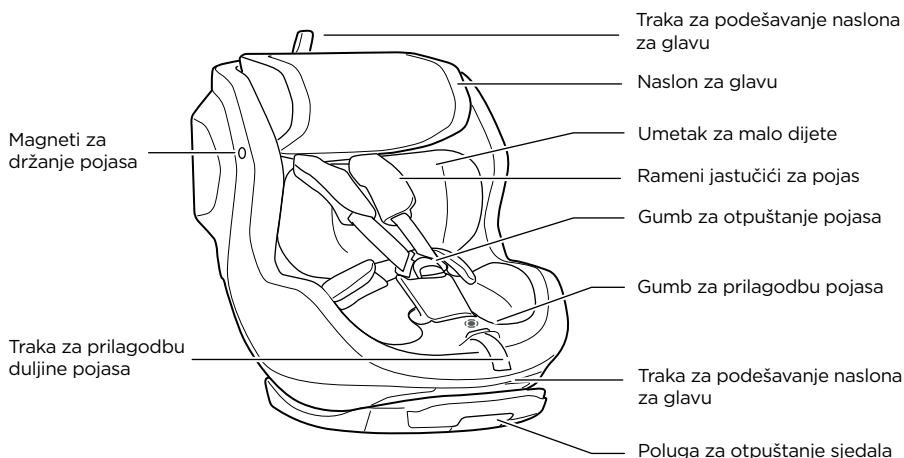

Kliknite na ovaj gumb da biste otišli na glavni izbornik

Συγχαρητήρια

Και σας ευχαριστούμε που επιλέξατε το κάθισμα Thule Elm! Να είστε βέβαιοι ότι έχουμε καταβάλει κάθε προσπάθεια και επιστρατεύσαμε όλες τις γνώσεις και το πάθος μας για να σχεδιάσουμε την πιο ασφαλή, αξιόπιστη και εύχρηστη βάση ISOFIX που σκεφτήκαμε ποτέ.

Οπτική γλώσσα



ΠΡΟΕΙΔΟΠΟΙΗΣΗ υποδεικνύει επικίνδυνη κατάσταση η οποία, εάν δεν αποφευχθεί, ενδέχεται να καταλήξει σε θάνατο ή επικίνδυνο τραυματισμό.



ΣΗΜΕΙΩΣΗ υποδεικνύει επιπλέον πληροφορίες οι οποίες είναι χρήσιμες για την απρόσκοπτη και βέλτιστη χρήση του προϊόντος.



Οπτικός έλεγχος - εντάξει



Οπτικός έλεγχος - σφάλμα

Click Ηχητικό κλικ

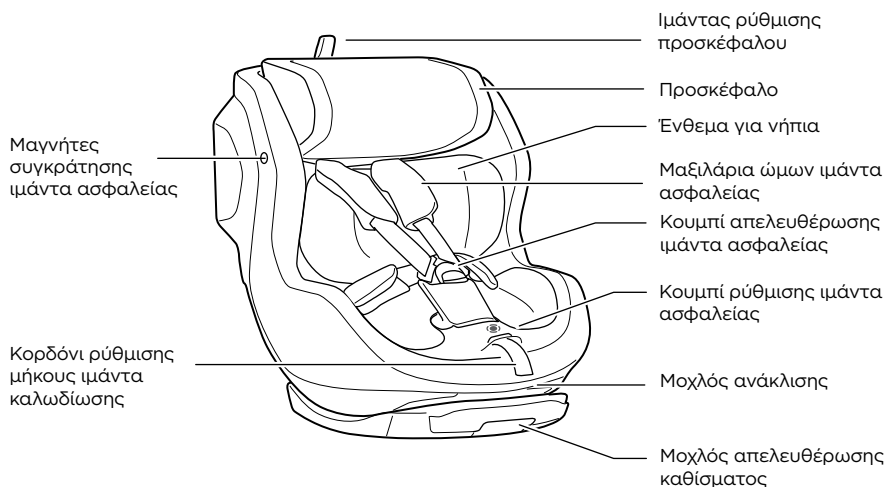

Κάντε κλικ σε αυτό το κουμπί για να μεταβείτε στο κύριο μενού

Tebrikler

Thule Elm ürününü tercih ettiğiniz için teşekkür ederiz!

Tüm çabamızı, bilgimizi ve tutkumuzu, düşünebileceğimiz en güvenli, güvenilir ve kullanımı kolay çocuk oto koltuğunu tasarlamak için ortaya koyduğumuzdan emin olabilirsiniz.

Görsel dil



UYARI, kaçınılmadığı takdirde ölüm veya ciddi yaralanmayla sonuçlanabilecek tehlikeli bir durumu belirtir.



Görsel kontrol - doğru



NOT, ürünün sorunsuz ve en uygun kullanımı için yararlı olan ek bilgileri gösterir.



Görsel kontrol - hatalı

Click Tıklama sesi

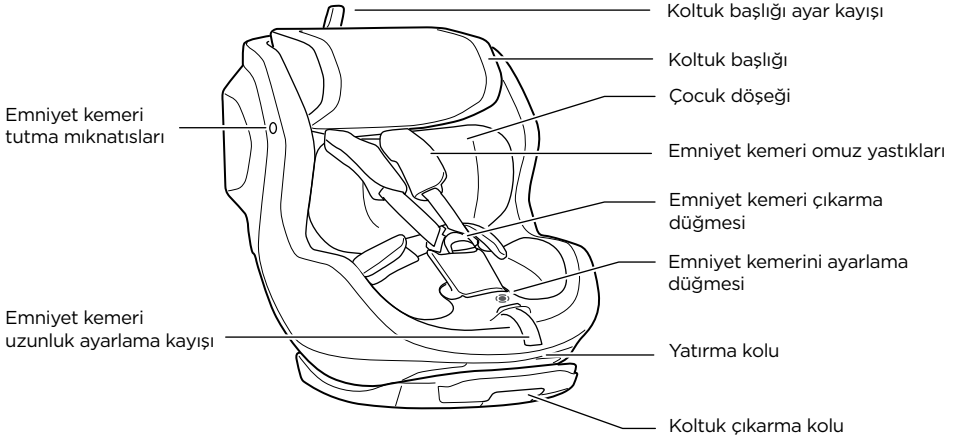

Ana menüye gitmek için
bu düğmeye tıklayın

تهانينا

وشكرًا لاختيارك Thule Elm! يمكنك الاطمئنان والتأكد بأننا بذلنا كل جهودنا ومعرفتنا وشغفنا في تصميم عربة الأطفال الأكثر أناقة ومرونة وأمانًا التي يمكن أن تفكر بها.

اللغة المرئية

الفحص البصري - جيد



تحذير يشير إلى موقف خطير قد يؤدي، عند عدم تجنبه، إلى الموت أو حدوث إصابة خطيرة.



الفحص البصري - خاطئ



ملاحظة تشير إلى معلومات إضافية مفيدة من أجل استخدام مثالي للمنتج خالي من المشاكل.



نقرة مسموعة

Click

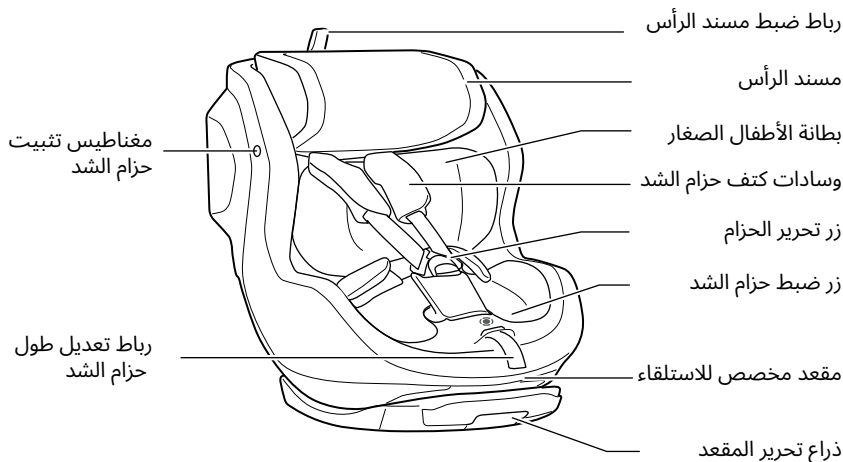

انقر فوق هذا الزر للانتقال إلى القائمة الرئيسية



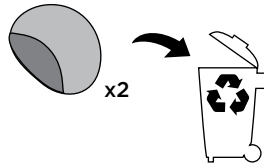
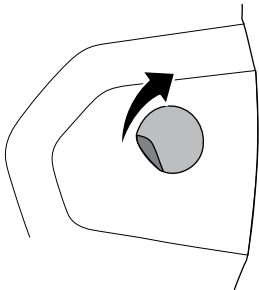
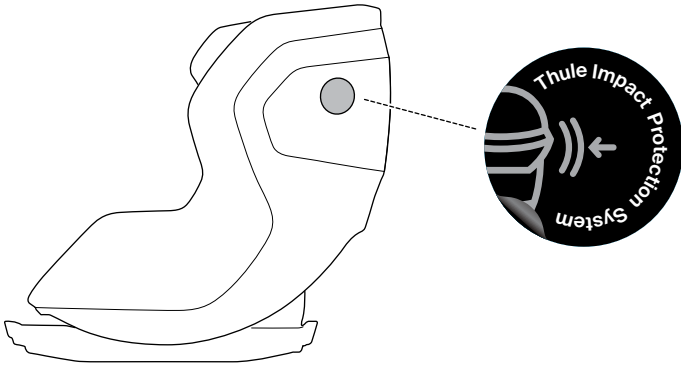
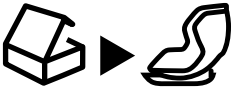

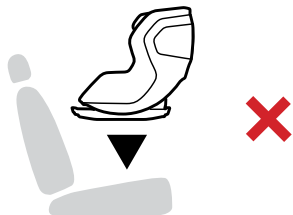
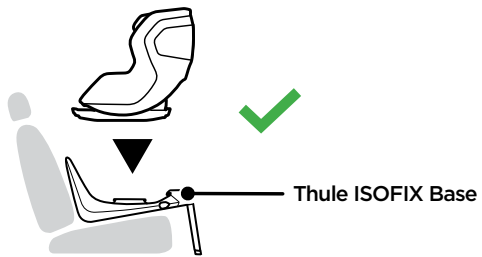
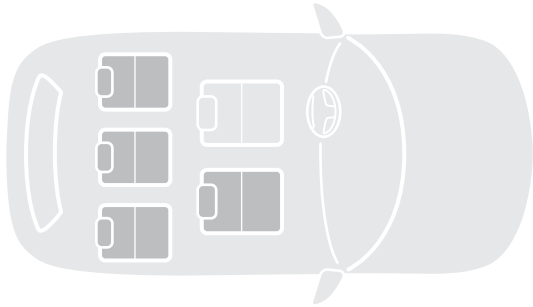

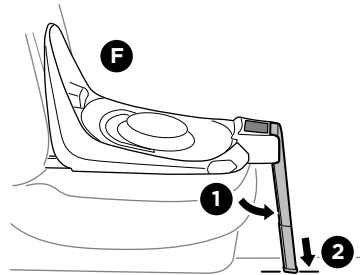
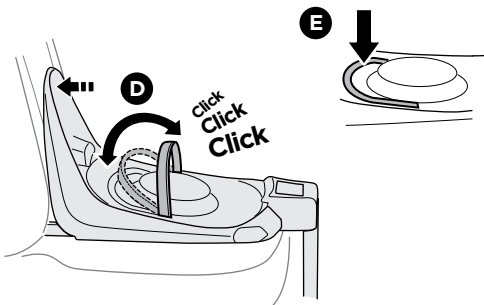
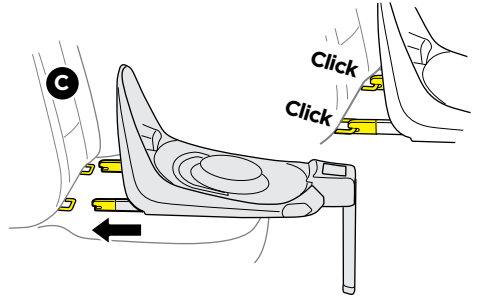
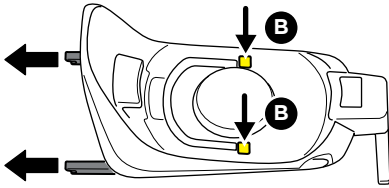
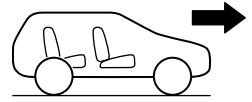
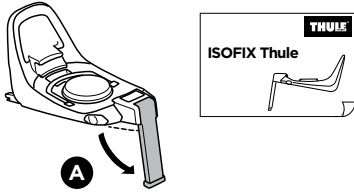
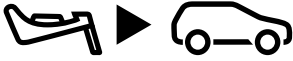

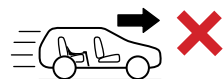
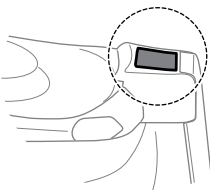

i





 67 - 105 cm
<15 M

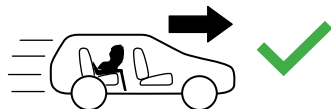
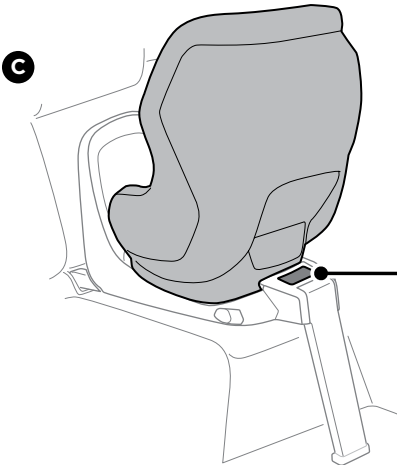
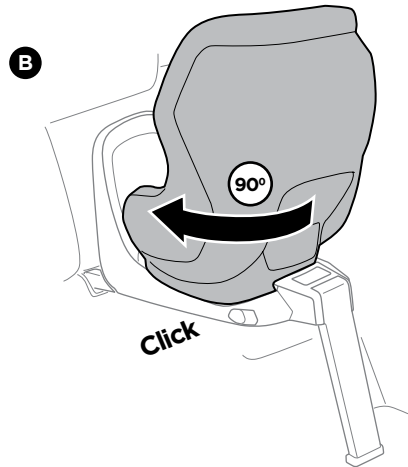
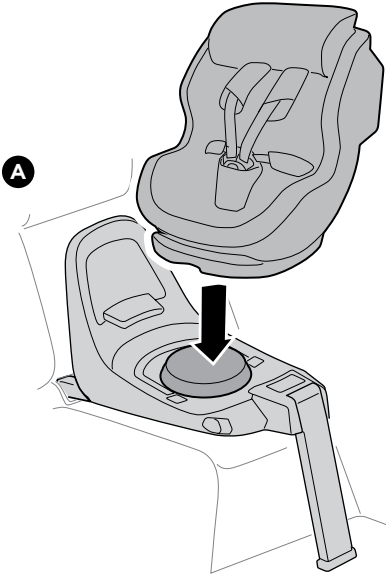
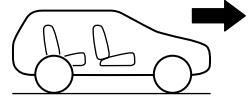



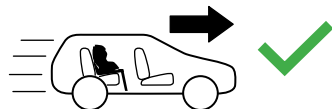
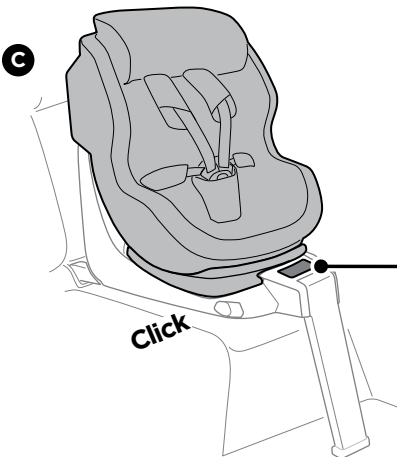
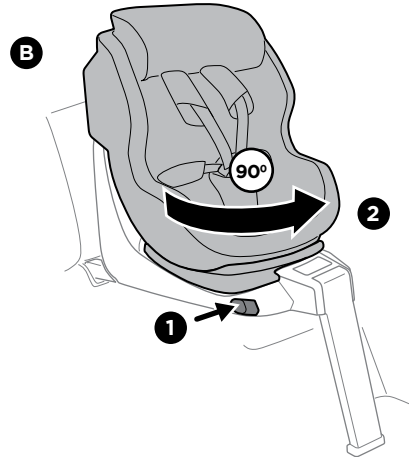
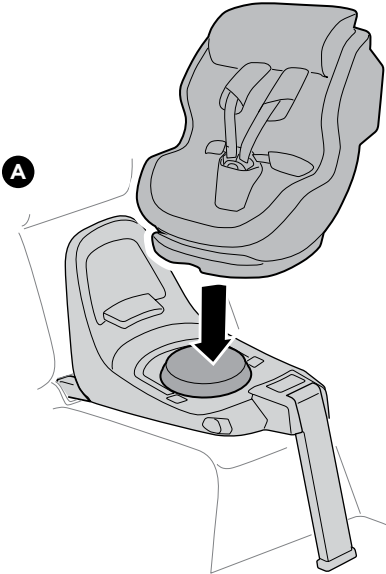
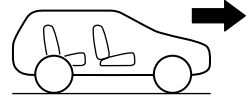

 76 - 105 cm

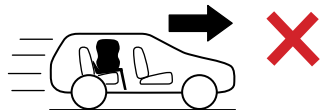
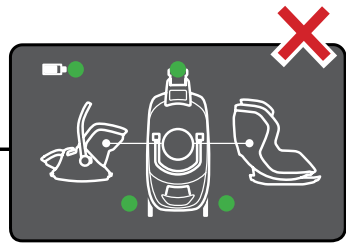
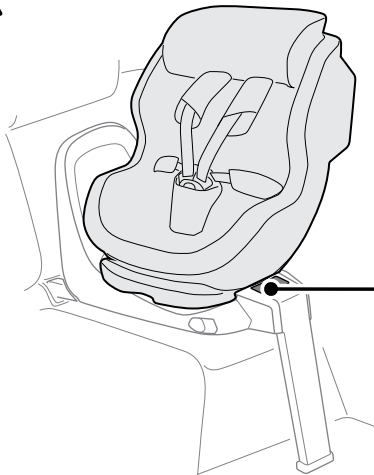
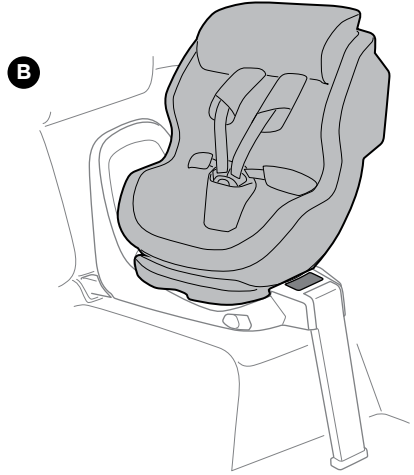
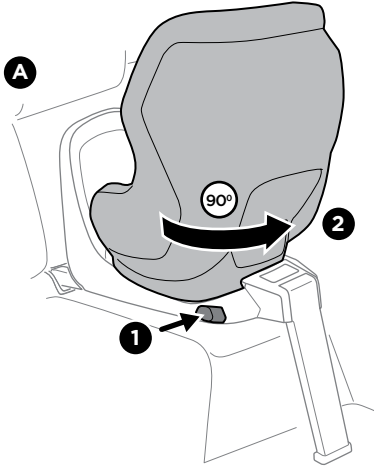
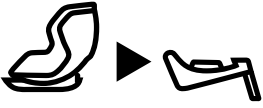

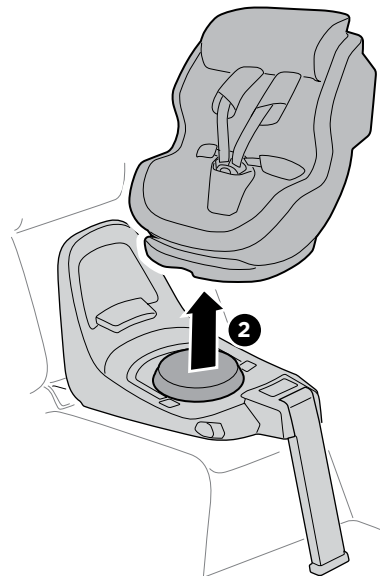
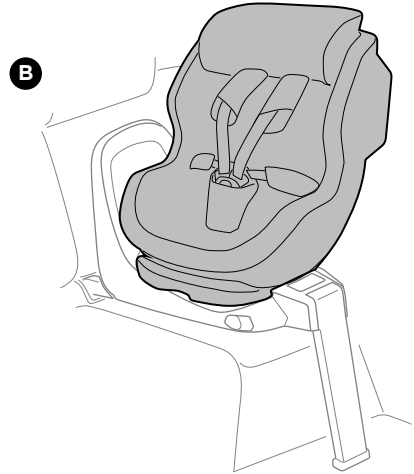
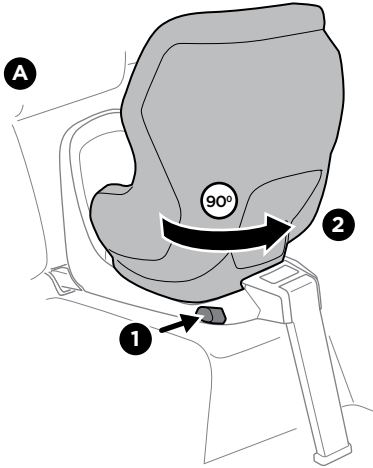
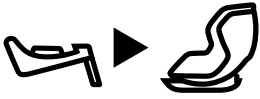





 67-105 cm / max 18 kg 



67-87 cm

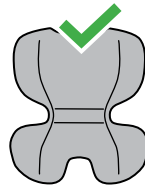
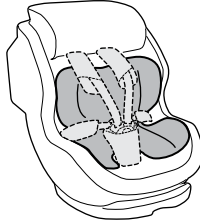

Thule toddler
car seat inlay



88-105 cm

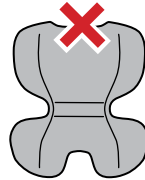
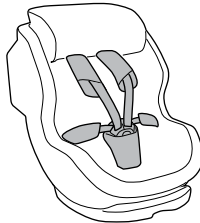

Thule toddler
car seat inlay

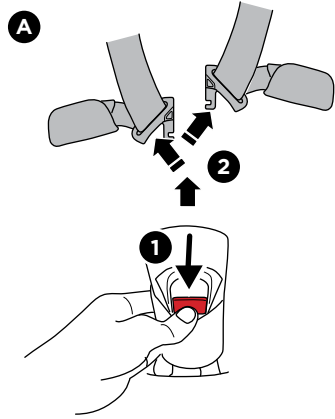
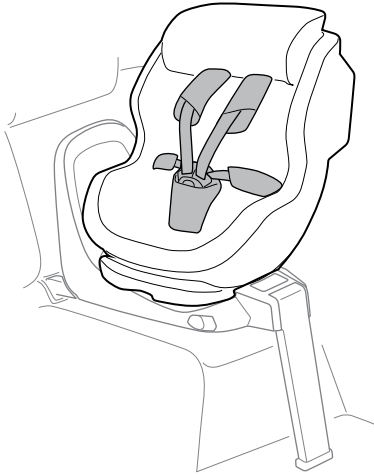
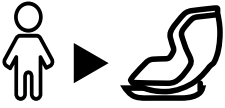

B

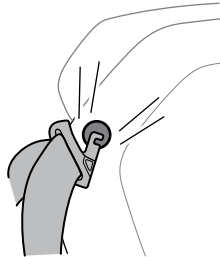
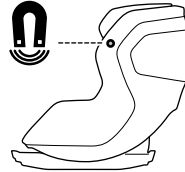
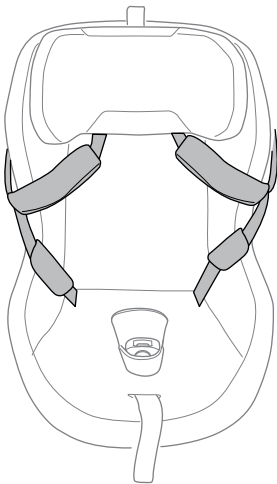

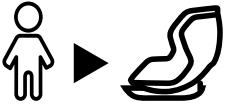

A

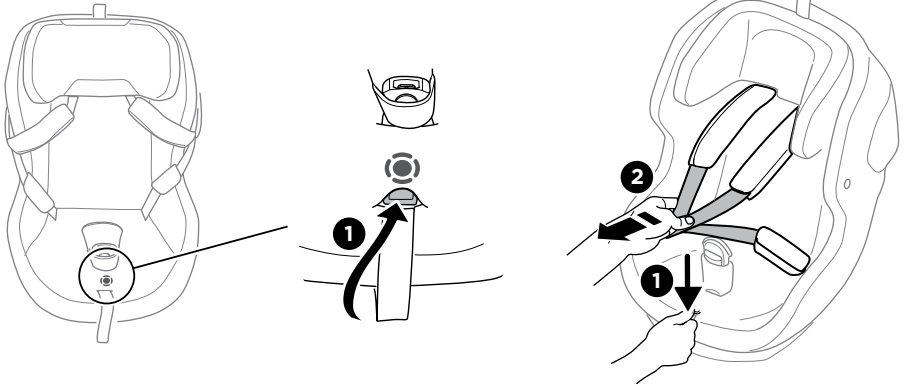
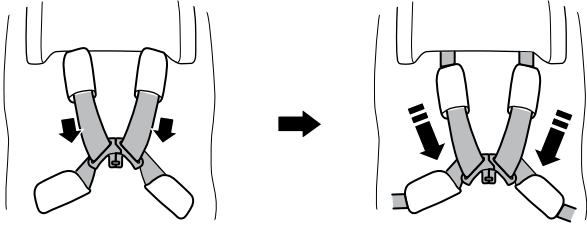

B

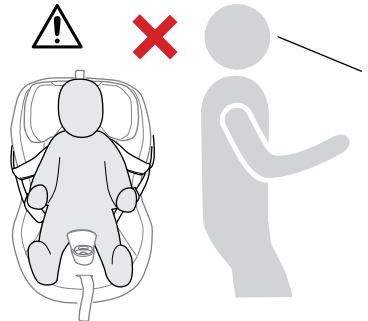
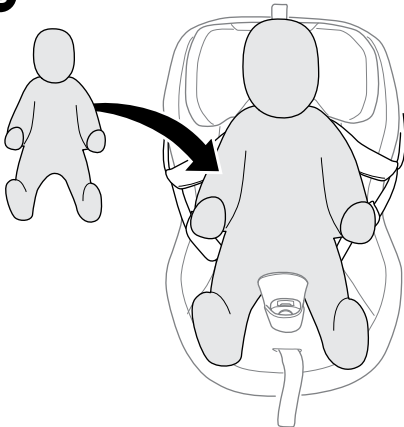

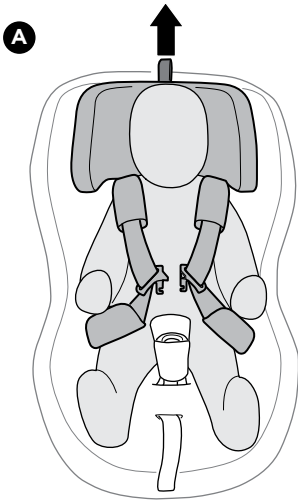
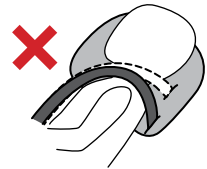
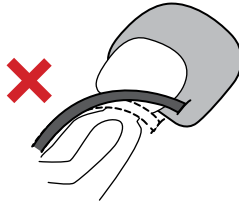
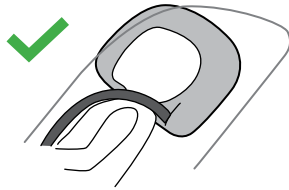
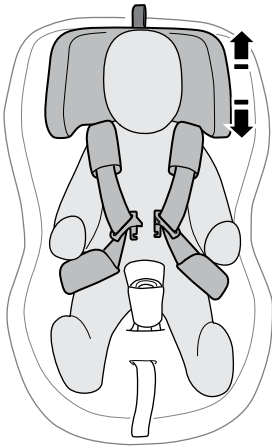

B

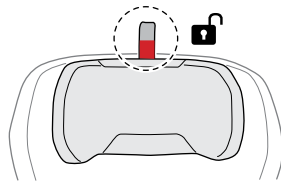
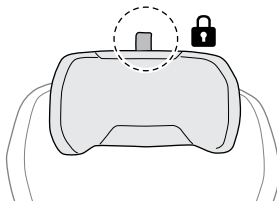
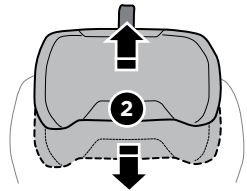
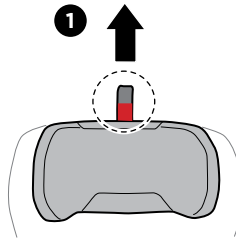

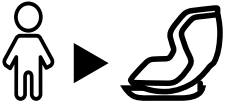

A

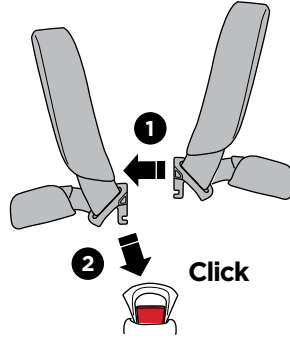
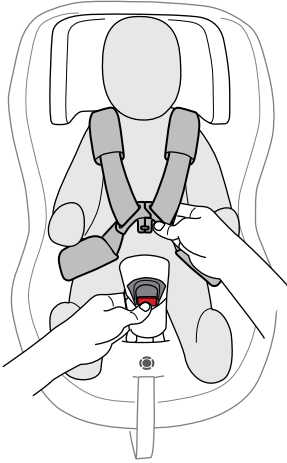

B

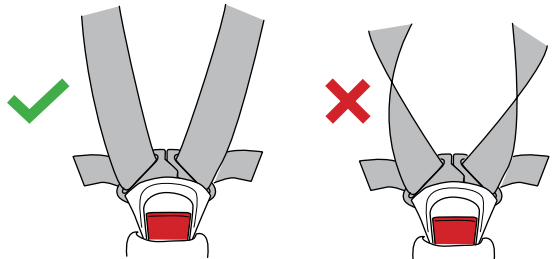
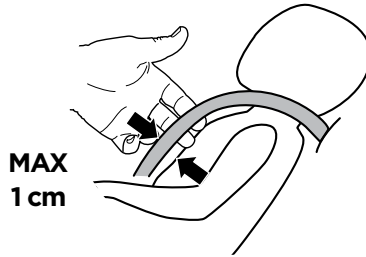
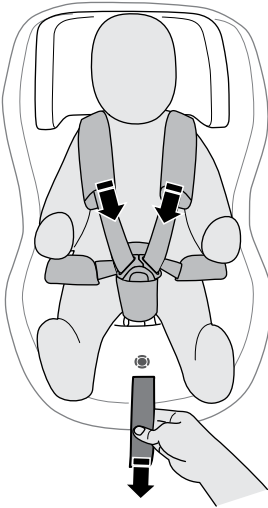

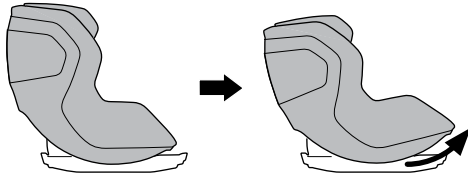

A

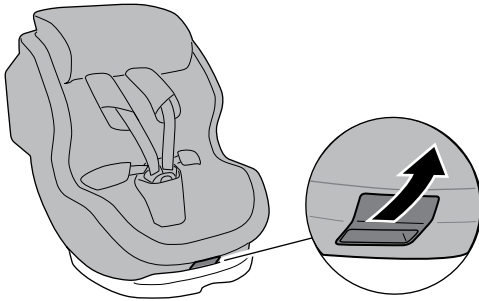

B



1.



2.

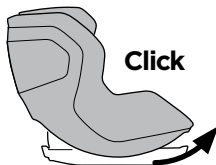

3.



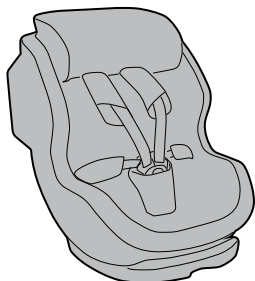

Scan to watch
instructional video



A

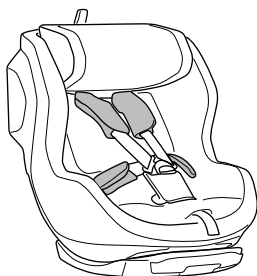

1

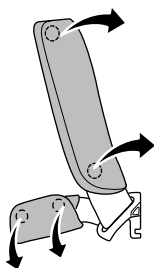

2

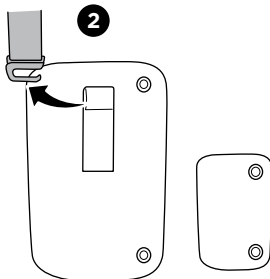



B

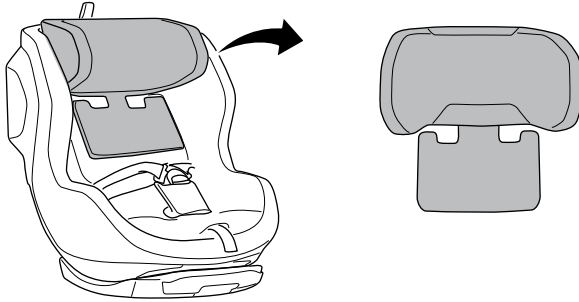

C

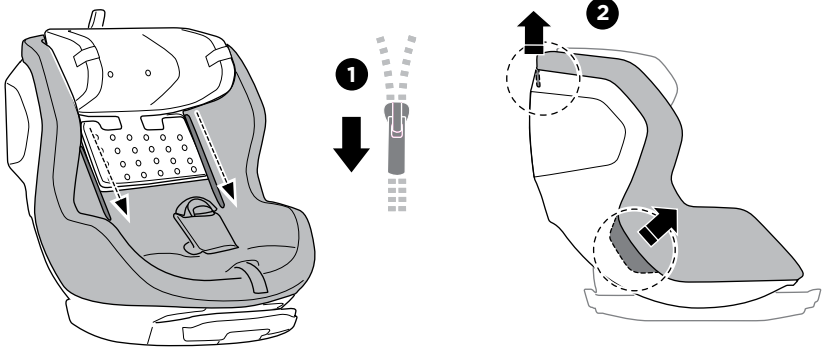

D

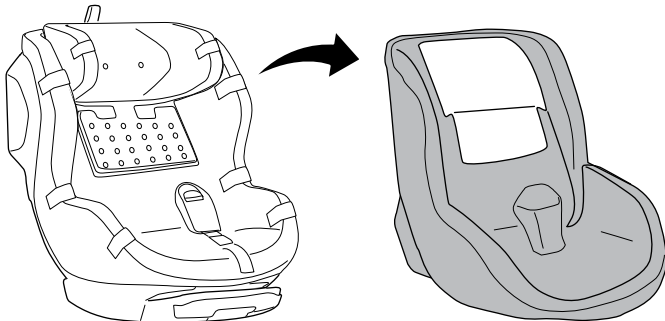

Thule Sweden AB
Borggatan 5
335 73 Hillerstorp, Sweden
info@thule.com
www.thule.com

© Thule Group. May 2024. All rights reserved.

» PART OF THULE GROUP