

doona™

Doona i

User guide

ECE R-129
EN 12790:2009
EN 1888-1:2018+A1:2022
40-85 cm
Up to 13 kg
Language: English

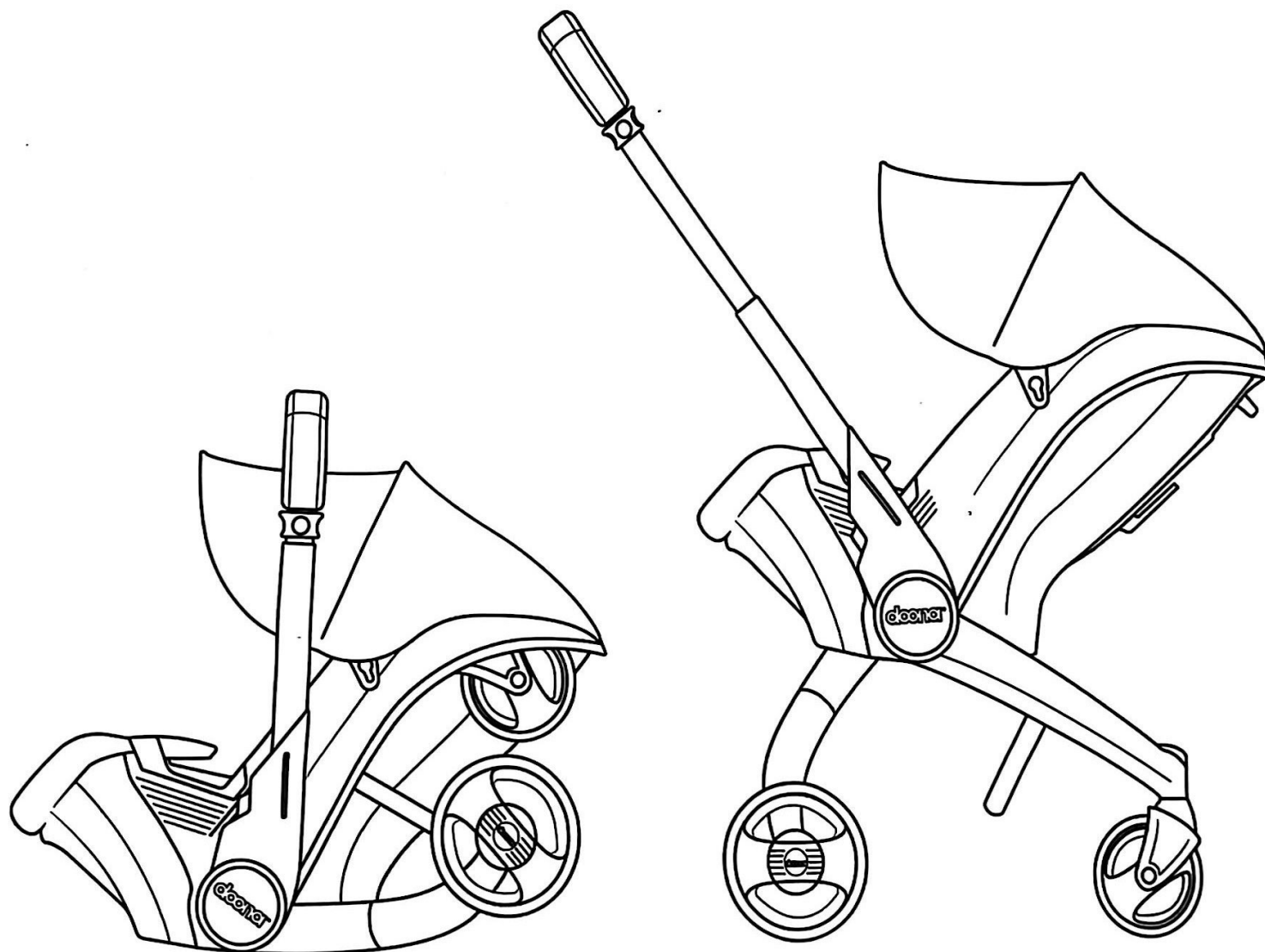

50652621

Table of Contents

1 / Warnings, vital information	7
2 / Doona i overview	13
3 / Adjustments	16
3.1 / Main modes	16
3.2 / Handle rotation	17
3.3 / Handle extension	18
3.4 / Parking Brake	19
3.5 / Securing your child using the harness	20
3.6 / Headrest height adjustment	22
3.7 / Newborn insert	24
3.8 / Doona SIP	25
4 / Unfolding & folding the doona i	27
4.1 / Unfolding the Doona i	27
4.2 / Folding the Doona i	28
5 / Securing the Doona i in the vehicle	30
5.1 / Securing the Doona i using the car seat belt	32
5.2 / Securing the Doona i ISOFIX base	34
5.3 / Installing the Doona i on the Doona i ISOFIX base	35

5.4 / Removing the Doona i from the Doona i ISOFIX base	37
6 / Care instructions	38
6.1 / Cleaning	40
6.2 / Textile undressing	41
6.3 / Textile dressing	44
7 / Aircraft installation	47
8 / Warranty	50
9 / Warranty card	51







Congratulations

Congratulations on choosing Doona i as your baby's safety and mobility solution. In order to protect your baby correctly, the Doona i car seat must always be used and installed as described in these instructions. Important-Keep these instructions for future reference. Read these instructions carefully, your child's safety may be affected if you do not follow these instructions. Please always keep the user instructions available in the compartment provided on the child seat. If you have any further questions regarding its use, please feel free to contact us at:

Dystrybutor w Polsce:
SCANDINAVIAN BABY Piotr Dmowski Sp.k.
Bażantów 18, 05-532 Łubna, Polska
tel. +48 22 7506302 email: info@
scandinavianbaby.pl
www.scandinavianbaby.pl

Manufactured by: Traveler Innovations Ltd
Made in China

1 / Warnings, vital information

-  **Important! keep for future reference**
-  **WARNING**
-  It is not permitted to make any modifications to the Doona i. Doing so nullifies or impairs its effectiveness in protection.
-  Regularly inspect the different elements of the Doona i. The harness system and buckle in particular must be checked regularly for wear and tear or possible damage.
-  Do not attempt to make adjustments while travelling.
-  Make sure that all movable parts of the Doona i are always properly locked in place and that no parts are lodged between movable seats or doors.
-  Never leave your baby unsupervised, especially not when the Doona i is placed on a high surface (nappy changing station, table, etc.).

- ⚠ Always secure the baby with the harness system (even when you are not using the Doona i inside the vehicle).
- ⚠ Do not place any heavy items on the rear window shelf, these can become dangerous projectiles in the event of an accident. Luggage or other heavy objects shall be properly secured.
- ⚠ Always fasten the Doona i with the Doona i ISOFIX base or vehicle belt when transporting it in your vehicle unoccupied.
- ⚠ Never use the Doona i seat without its original cover, it forms part of the safety concept.
- ⚠ Shield the Doona i seat from direct sunlight to prevent uncomfortable heating of the surface.
- ⚠ Schedule breaks during longer trips and take your baby out of the Doona i to relieve the pressure on its spinal column.

- ⚠ Do not use the Doona i anymore if parts have been damaged or after an accident (at an impact speed greater than 10 km/h)!
- ⚠ The Doona i is suitable for children from 40 to 85cm height, and up to 13 kg maximum.
- ⚠ For the protection of your baby this Doona i is not suitable for the following:
 - As a substitute for a cot or a cradle. Carrycots, pushchairs and buggies must only be used to transport babies or children.
 - To transport more than one child.
 - For commercial use.
- ⚠ In a case of car accident violent stresses occur, if you were involved in a car accident we recommend you to change the device.

- ⚠ Do not make any alterations or additions to the Doona i.
- ⚠ Do not use this product if any components are broken or missing.
- ⚠ Any luggage or other objects liable to cause injuries in the event of a collision shall be properly secured.
- ⚠ Never leave the child unattended.
- ⚠ Once your child can seat unaided.
Do not use the Doona i as a reclined cradle.
- ⚠ The Doona i is not intended for prolonged periods of sleeping.
- ⚠ Do not let your child play with this product.
This product is not suitable for running or skating.

- ⚠ When outside of the car, always use the parking brake when placing and removing the child from the Doona i, or when standing still.
- ⚠ It is dangerous to use the Doona i on an elevated surface, e.g. A table.
- ⚠ Always use the restraint system.
- ⚠ The Doona i does not replace a cot or a bed. Should your child need to sleep, then they should be placed in a suitable cot or bed.
- ⚠ Do not use accessories or replacement parts other than those approved by the manufacturer.
- ⚠ Ensure that all the locking devices are engaged before use. To avoid injury ensure that your child is kept away when unfolding and folding this product.

- ⚠ When folding and unfolding the Doona i, ensure that your child is either restrained with the harness (arms and legs are kept away from moving parts), or kept away when not seated.
- ⚠ Do not overload the Essentials Tote bag with weights of over 2.5 kg.
- ⚠ Do not overload the Essentials bag with weights of over 1.5 kg.
- ⚠ Exceeding these limits may compromise the stability of the stroller and cause it to topple over. Load carrying accessories which are not approved by the manufacturer should not be used.
- ⚠ Any load attached to the handle affects the stability of the Doona i.
- ⚠ Important note: You must remove all bags from the Doona i before folding the wheels and transferring to Car Seat mode.

2 / Doona i overview

- Canopy ①
- Canopy rotation hinge ②
- Handle ③
- Handle rotation buttons (2x) ④
- Parking brake pedal ⑤
- Parking release pedal ⑥

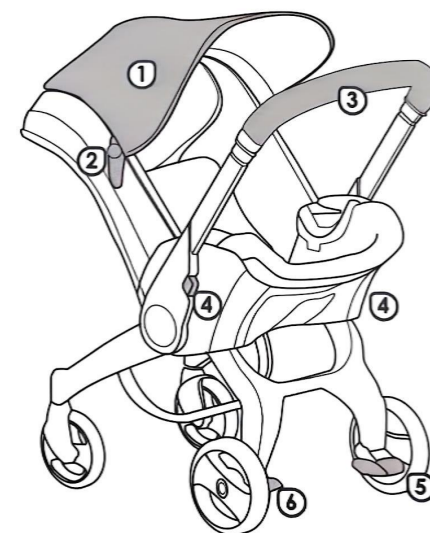

- Handle extension buttons (2X)..... ⑦
- Folding lever ⑧
- Lap belt guides (2X) ⑨
- Shoulder belt guide ⑩
- Rear wheels quick release buttons (2x)..... ⑪

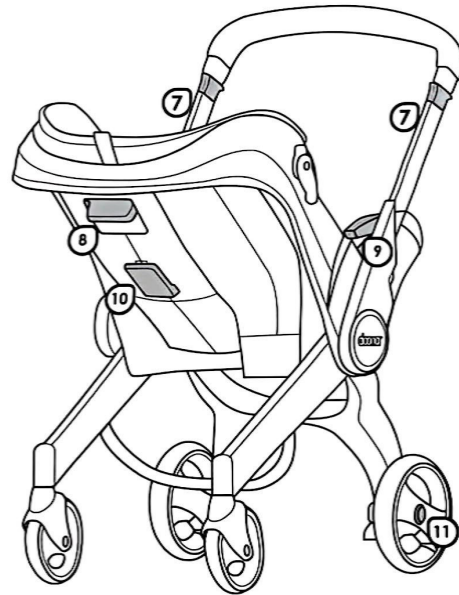

- Headrest height adjustment strap ①
- Headrest ②
- Shoulder straps velcro (2X) ③
- Shoulder pads (2X) ④
- Buckle & buckle tongues ⑤
- Buckle release button ⑥
- Harness release button ⑦
- Harness tightening strap ⑧

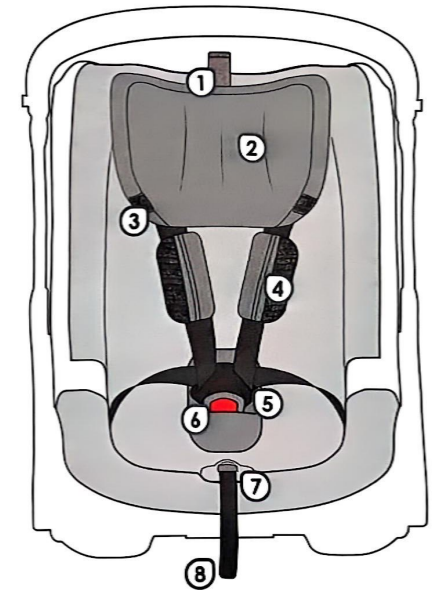

3 / Adjustments

3.1 / Main modes



Car seat
(use with
vehicle belt)

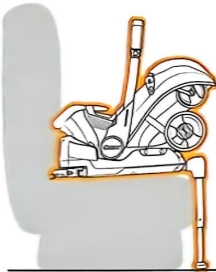

Car seat (i-Size)

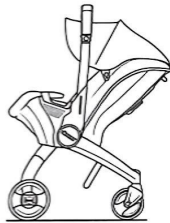

Carry



Stroller

3.2 / Handle rotation

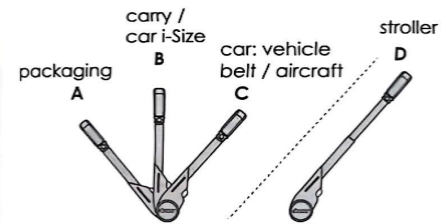

⚠ ATTENTION

The Doona i handle must be in its shortest mode to allow this function to work.

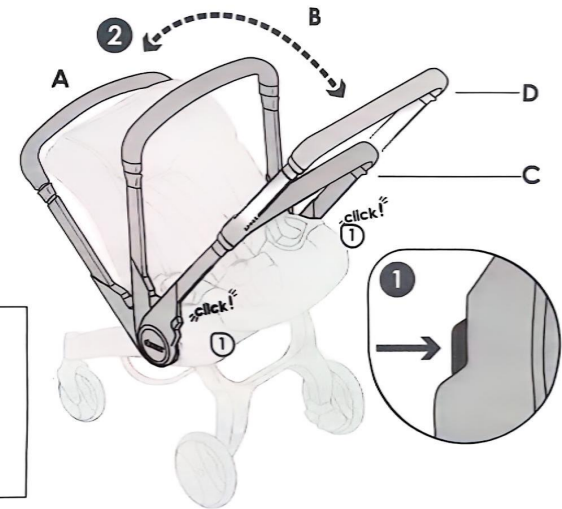

3.3 / Handle extension

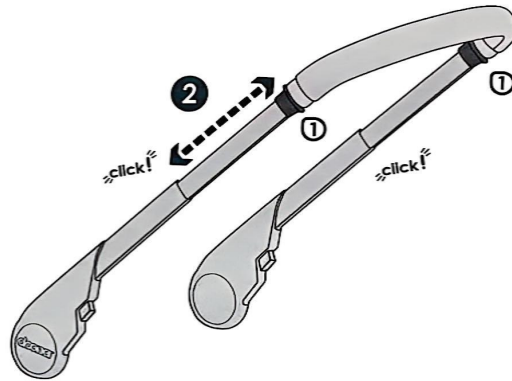

⚠ ATTENTION

The Doona i handle must be in stroller mode to allow this function to work.

3.4 / Parking Brakes

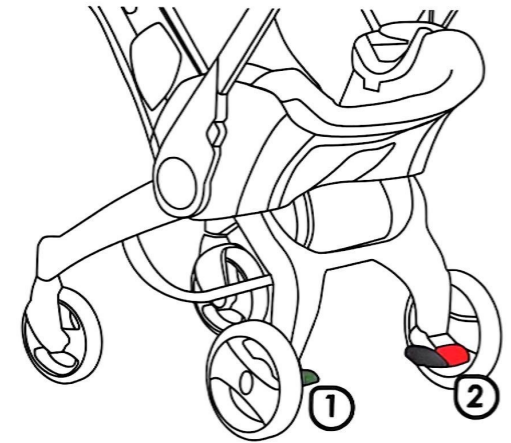
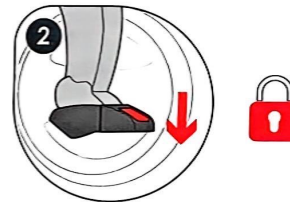
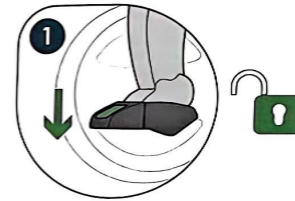

3.5 / Securing your child using the harness

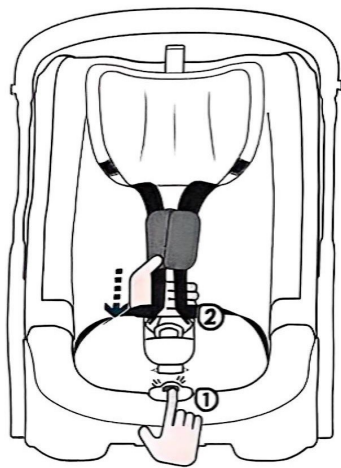

Loosening

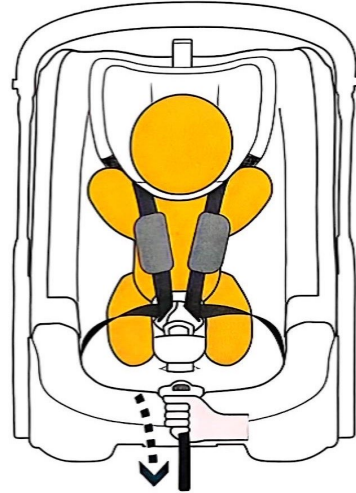

Tightning

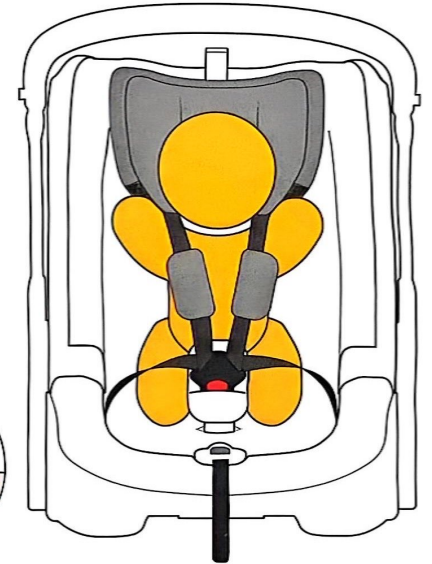

3.6 / Headrest height adjustment

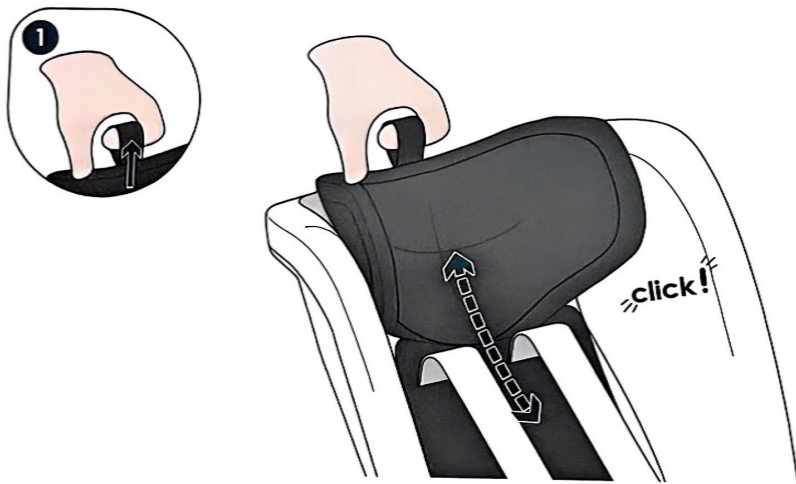

Adjusting the headrest to your baby's height

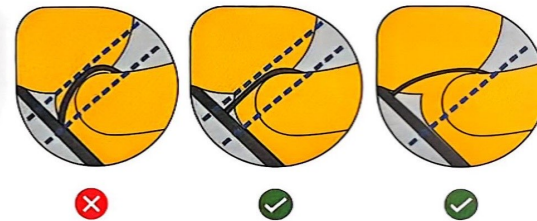

⚠ ATTENTION

The positioning of the headrest height should be according to your baby's shoulder level or slightly above.



3.7 / Newborn insert

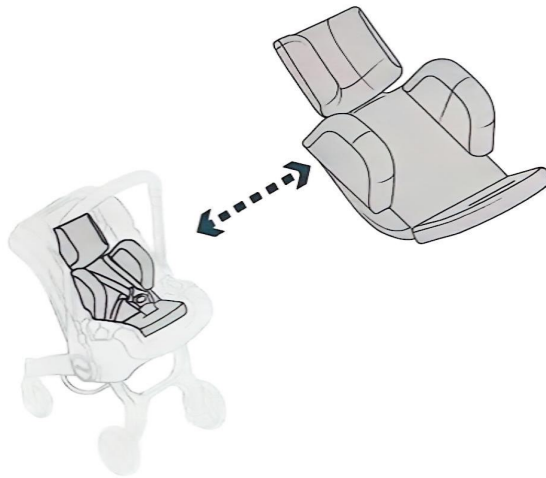

⚠ ATTENTION

Stop using the newborn inlay when your baby is bigger than the advised weight or size.

3.8 / Doona SIP

Doona SIP add-on provides enhanced side-impact protection, which better protects the baby by absorbing energy in case of a side accident.

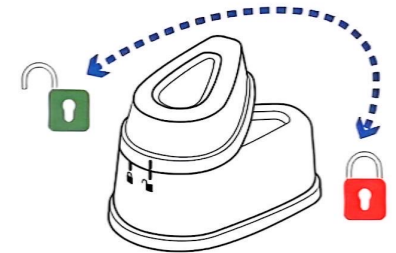
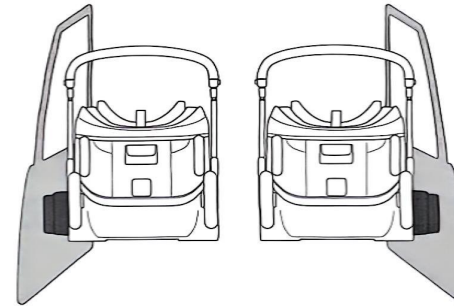

⚠ ATTENTION

The doona SIP should only be attached on the side closer to the car door, and removed when out side of the car.

⚠ ATTENTION

When installing the doona i car seat in a vehicle, if needed adjust the doona SIP height by removing the second layer.

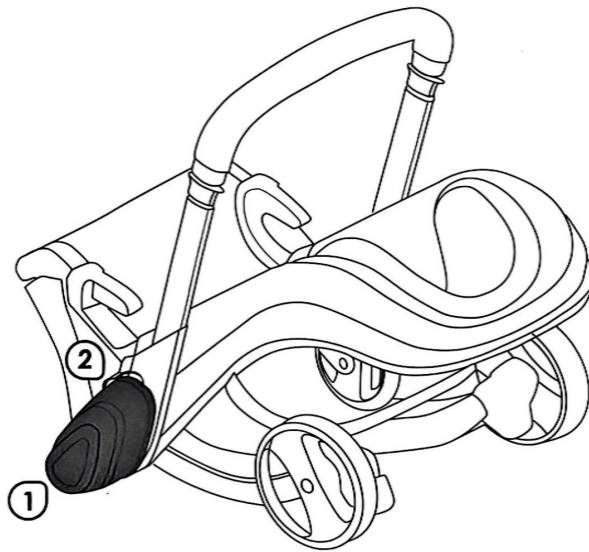
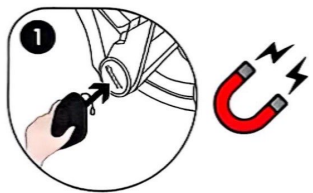

4 / Unfolding & folding the doona i

4.1 / Unfolding the Doona i

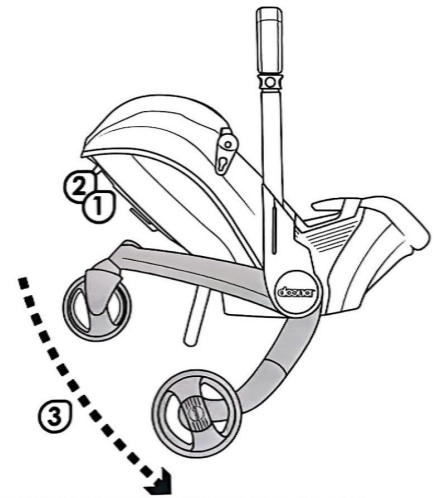

4.2 / Folding the Doona i

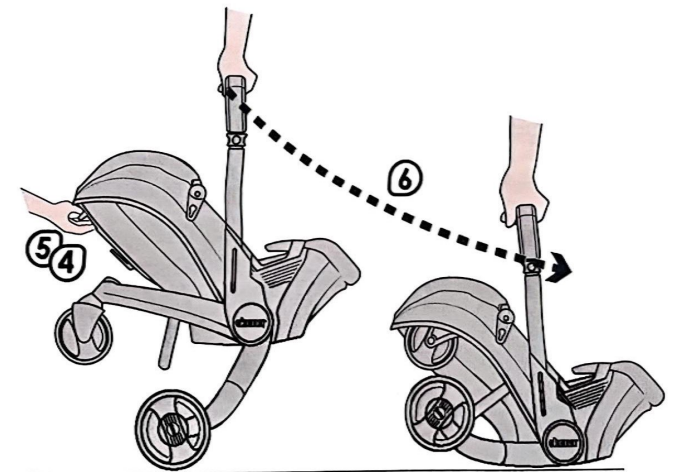
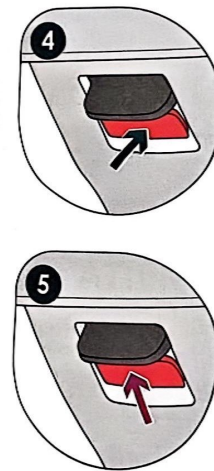
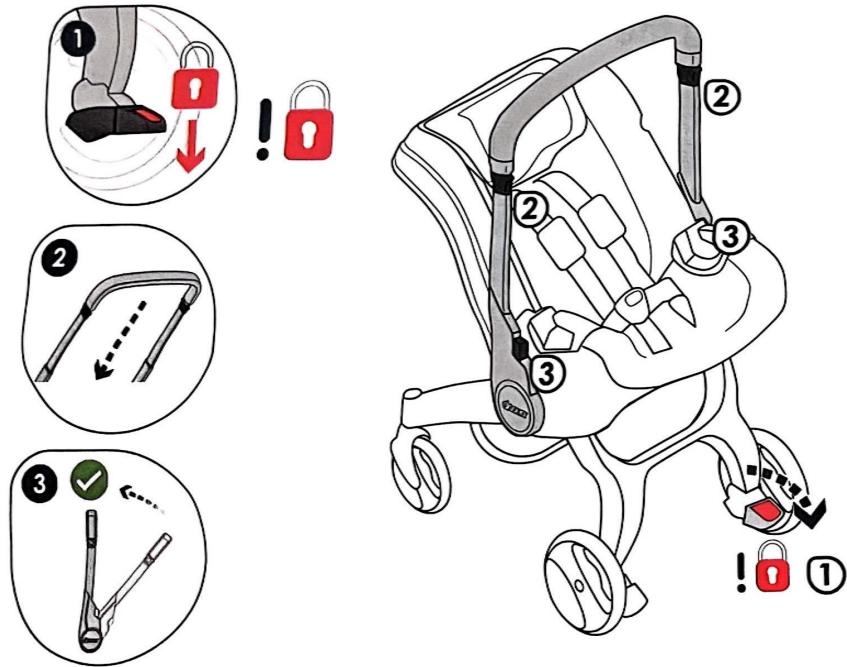

5 / Securing the Doona i in the vehicle

In case the Doona i isn't fitting on a specific seat position of the vehicle please remove the back side stroller wheels when using as a car seat!
Do that by pushing the wheel release button.
Don't forget to re-assemble the wheels when using as stroller!

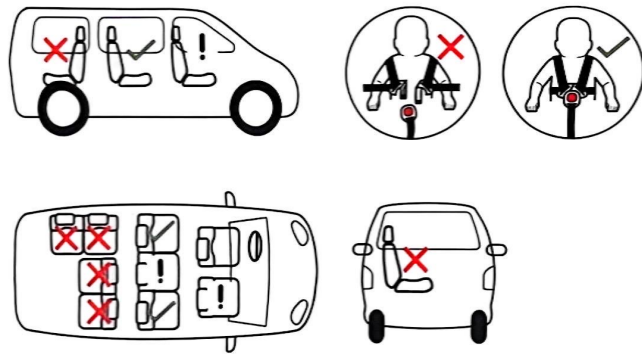

⚠ ATTENTION

An airbag hitting the Doona i can cause serious injuries to your child, possibly resulting in death. Doona i is suitable if the vehicles are fitted with an adult belt approved to ECE R16.

⚠ ATTENTION

Make sure that the Doona i is placed against driving direction on a forward facing vehicle seat.

⚠ ATTENTION

Make sure that the vehicle seat belt is not twisted. Make sure that all belts are tightened at all times.

5.1 / Securing the Doona i using the car seat belt

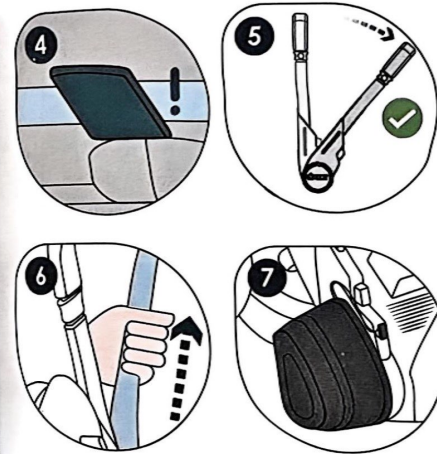
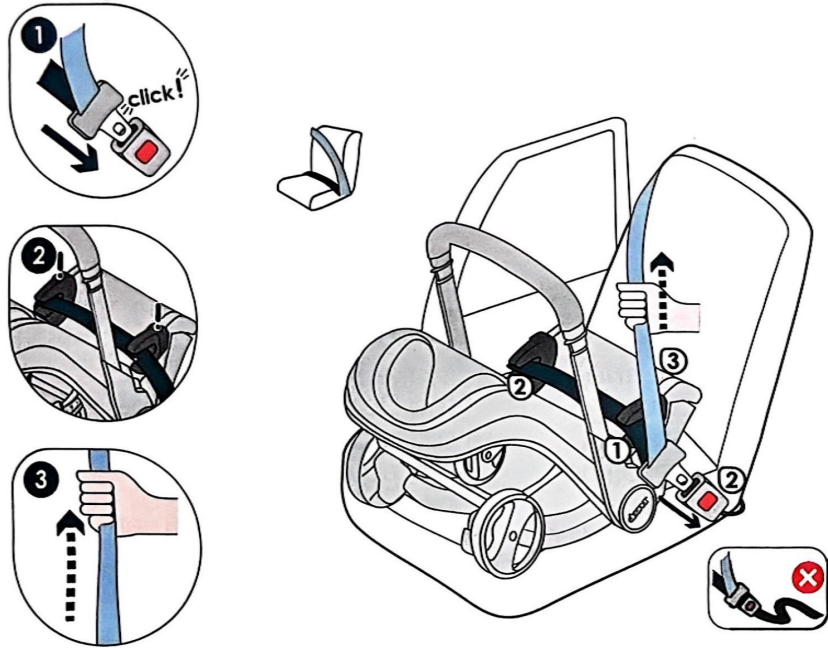

5.2 / Securing the Doona i ISOFIX base



⚠ ATTENTION

The Doona i ISOFIX base has to be properly installed to the car seat according to the ISOFIX base user instructions. Look up the ISOFIX base user guide for full instructions.

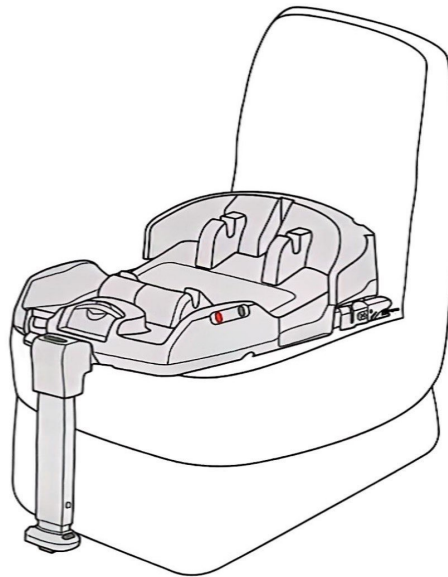

5.3 / Installing the Doona i on the Doona i ISOFIX base

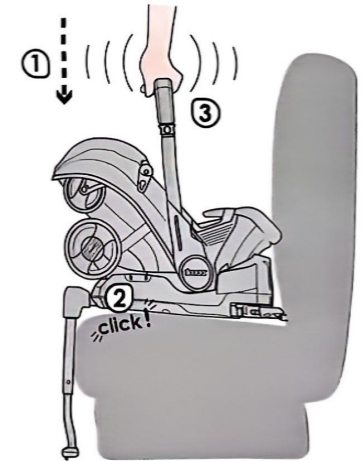
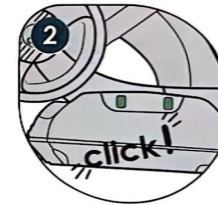

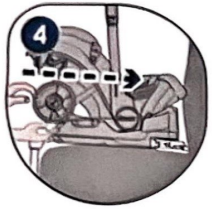

5.4 / Removing the Doona i from the Doona i ISOFIX base

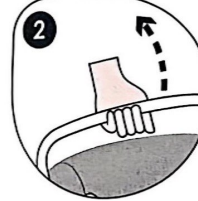
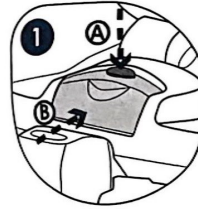

⚠ ATTENTION

For more detailed instructions see the Doona i ISOFIX base user guide

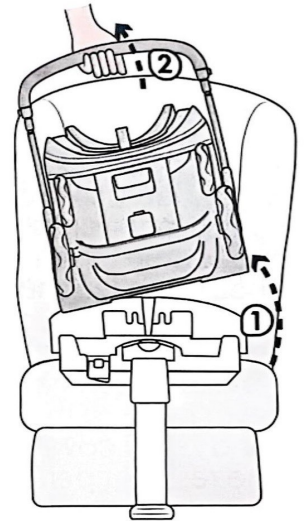

6 / Care instructions

To retain the protective effect

- In an accident at a collision speed above 10 km/h the Doona i could suffer damage which is not necessarily obvious. In this case the car seat must be replaced. Please dispose of it properly.
- Regularly check all important parts for damage. Ensure the correct operation of all mechanical components.
- To prevent damage or breakage, ensure that the Doona i does not become jammed in the car door, seat runners, etc.
- Should the Doona i be damaged (for example after dropping it) it must be inspected.
- The Doona i must not be used without the seat cover
- Never use spare parts or accessories other than those supplied – never replace the seat cover with any other than the original Doona i seat cover, because the cover constitutes an integral part of the restraint performance.

WARNING

Only the following cleaning procedure should be used. Deviation from this procedure may result in injury or death.

Care for the harness buckle

For easy cleaning use wet wipes

NOTE - the harness cannot be removed from the product.

NEVER USE TOOLS TO PROBE INSIDE THE BUCKLE nor HOT AIR DRYERS . Damage to the buckle may occur resulting in reduced performance that may result in injury or death.

NEVER APPLY LUBRICANTS TO THE BUCKLE. Damage to the buckle may occur resulting in reduced performance that may result in injury or death.

6.1 / Cleaning

Always use only genuine Doona i fabric covers, since the seat cover is an integral part of the Doona i system. Using the original seat covers helps to maintain a safe and functioning system.

- The seat cover can be removed and washed with a mild detergent. Follow these washing instructions to avoid damage to the seat cover: Hand wash, cold; Do not bleach; Do not tumble dry; Hang dry; Do not wring; Do not iron; Do not dry clean. Please observe the instructions on the washing label of the cover. The same washing instructions should be followed when washing the sunshade as well.
- The plastic parts can be cleaned using soapy water. Do not use harsh cleaning agents (such as solvents).

6.2 / Textile undressing

Undressing - Canopy

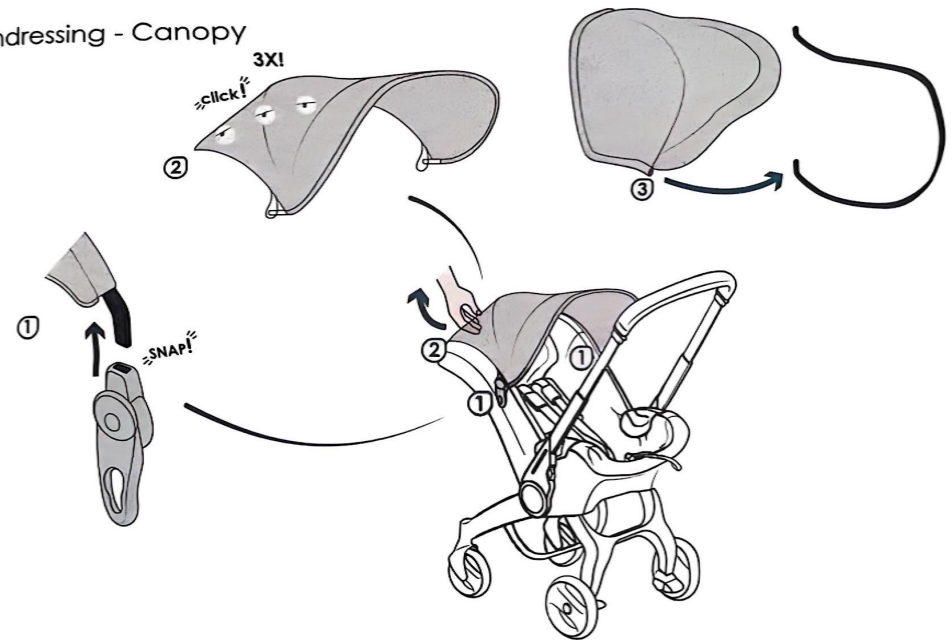

Undressing - Headrest cover & shoulder pads

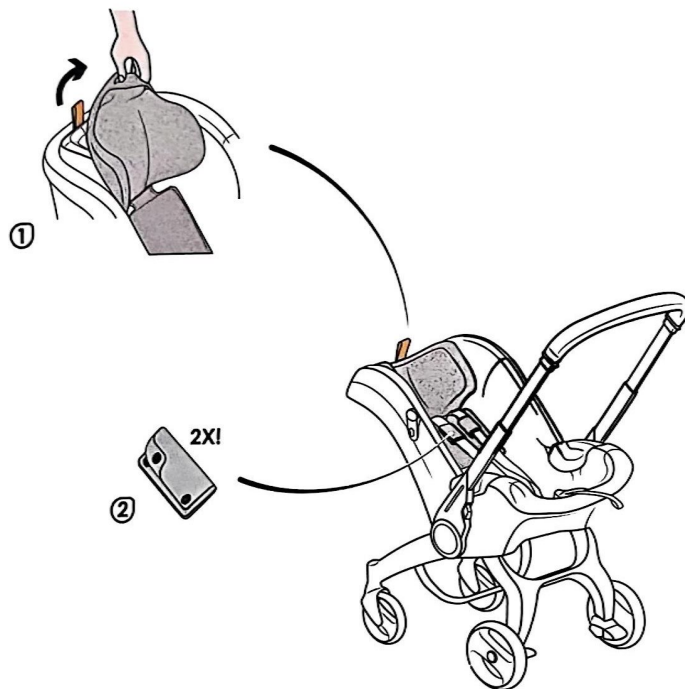

Undressing - Seat cover

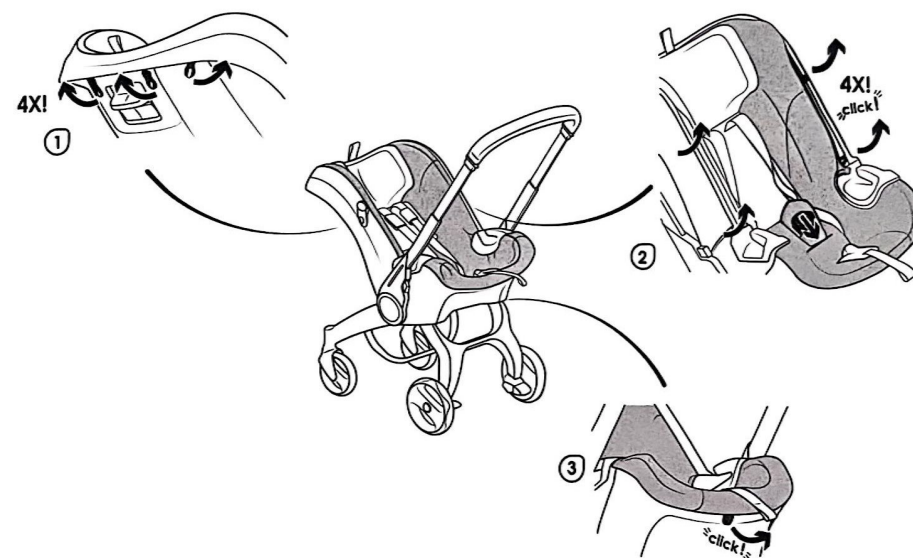

6.3 / Textile Dressing

Dressing - Headrest cover
& shoulder pads

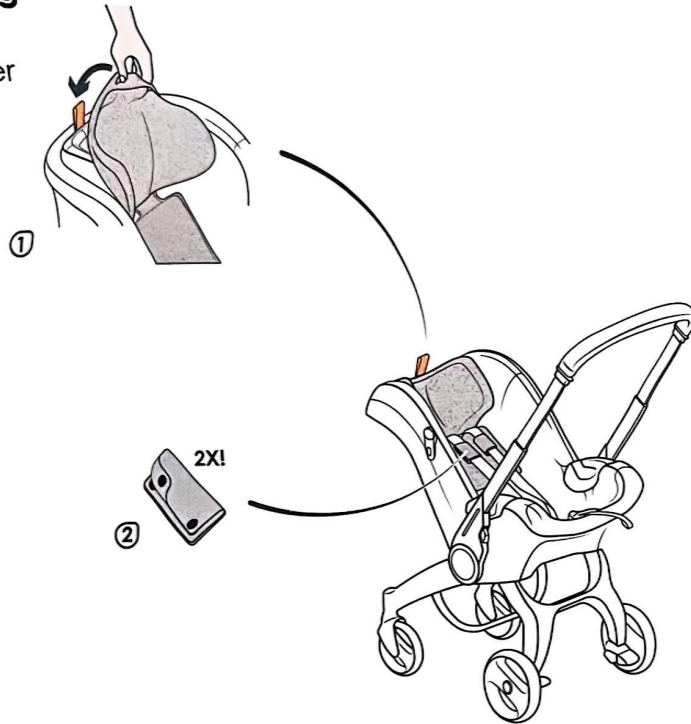

Dressing - Seat Cover

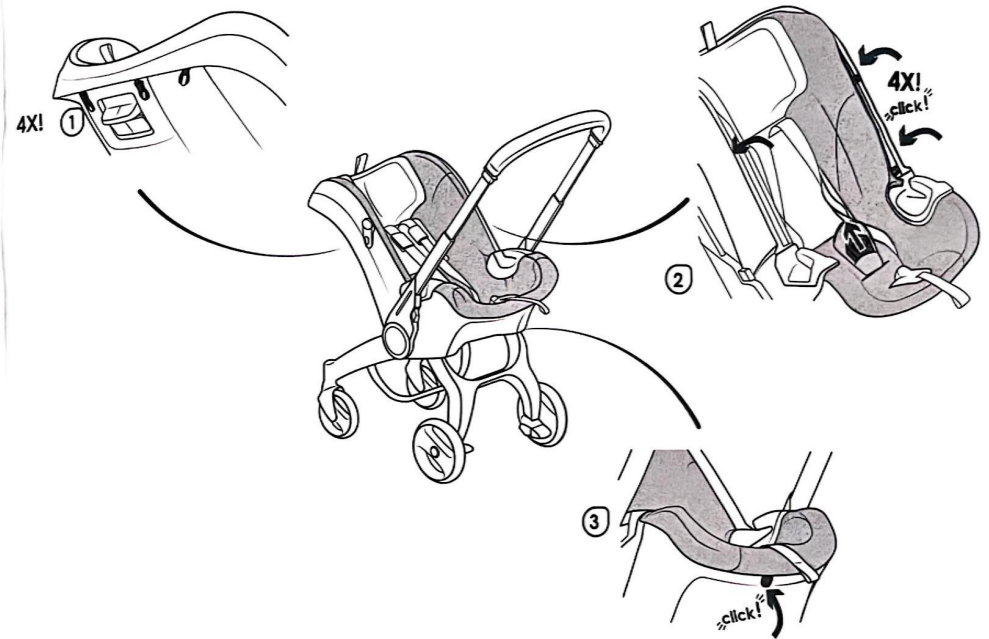

Dressing - Canopy

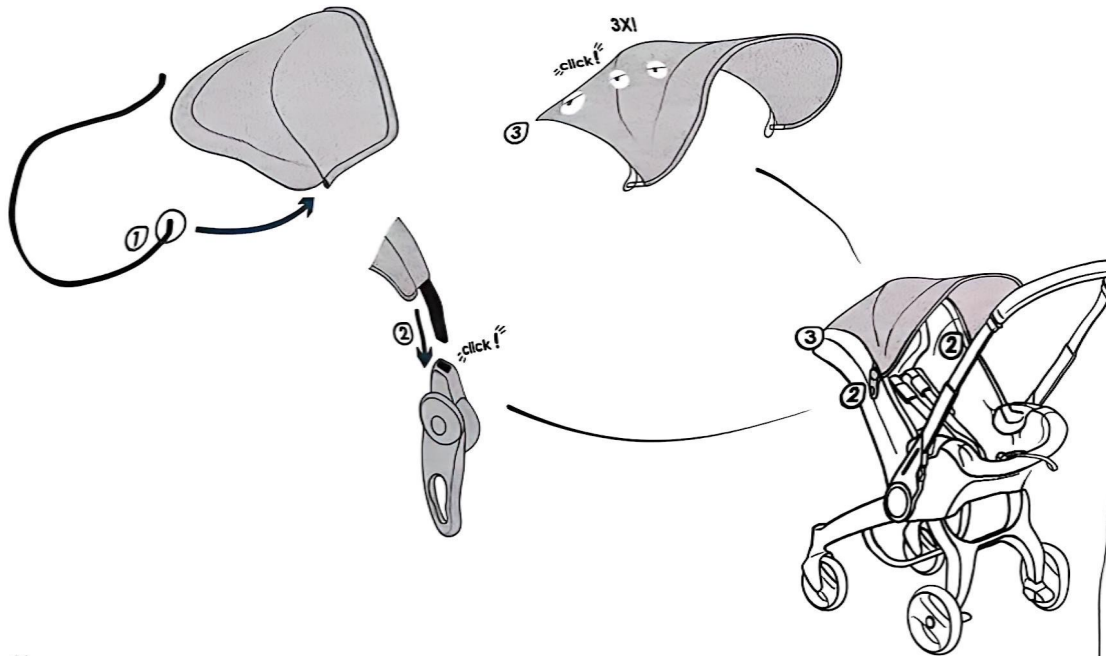

7 / Aircraft installation

Introduction

Doona strongly recommend that children up to 13 Kg use a certified harnessed child restraint or other device approved for aircraft travel. Doona i can also be used in an aircraft to ensure a safe flight of a baby on an airplane. When installing Doona i on an airplane, install it as shown on page 50.

Carrier installation Lap Belt only routing method.

Certification

Doona i is approved for use in aircrafts by TUV Rheinland global aviation experts. TUV Rheinland adhere to current standards, measurements and functionality requirements of National and International regulatory associations and international aviation authorities.

- The Doona i has to be secured in same way even when unoccupied and no child is in seat.
- Always consult your airline before flight regarding the use of car seats on plane.
- The Doona i must remain belted on the aircraft seat even when unoccupied.
- Doona i is only for use on a passenger seat authorized by the airline.



⚠ ATTENTION

The Doona i is not allowed to be used on aircraft seats equipped with an active airbag.



⚠ ATTENTION

The Doona i can only be used on approved forward facing aircraft seating positions.

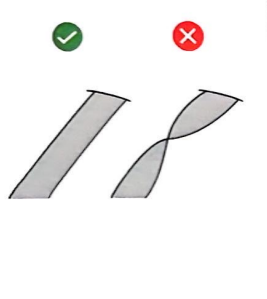

⚠ ATTENTION

Make sure that the aircraft seat belt is not twisted.



⚠ ATTENTION

Do not use the doona SIP on an aircraft.

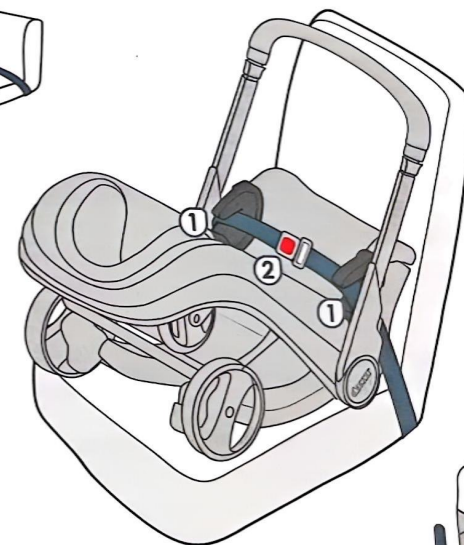
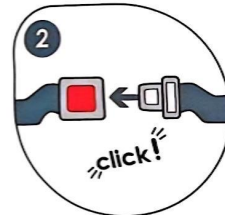

8 / Warranty

We guarantee that the Doona i car seat has been manufactured in accordance with the European safety standards and regulations, and is meeting the highest standards of quality. For the Doona i car seat we provide a 2-year warranty against manufacturing or material defects.

The warranty period is effective from the day of purchase.

As proof of purchase we ask that you fill out the Warranty Card and retain it for the whole term of the warranty period, together with your sales receipt. In the case of a warranty claim the Warranty Card must be returned together with the product to your local distributor.

Please also register your Doona i car seat online at: **www.doona.com**

The Warranty covers Doona i car seats which have been handled properly and which have been sent to us in a clean condition.

The warranty does not apply in the following cases:

- Natural signs of wear and damage resulting from excessive stress.
- Damage resulting from inappropriate or improper use.
- When the product has been used for a purpose other than that provided for in the instructions for use.

In the event of a warranty claim, please contact us directly at: **info@doona.com**