

 **cybex**
PLATINUM

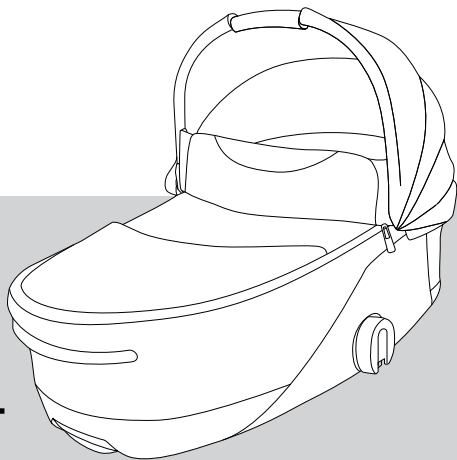

FOLD
LUX CARRY COT



EN WARNING
DE WARNUNG
ES ADVERTENCIA
FR AVERTISSEMENT
PT AVISOS
IT WARNING
NL WAARSCHUWING
PL OSTRZEŻENIE
CS UPOZORNĚNÍ
SK UPOZORNENIE
SL OPOZORILO
HR UPOZORENJE
HU FIGYELMEZTETÉS
SE VARNING
NO ADVARSEL
FI VAROITUS
DA ADVARSEL
ET HOIATUS
LV BRĪDINĀJUMS
LT PERSPĖJIMAS
RU ВНИМАНИЕ
UK УВАГА
TR UYARI
EL ΠΡΟΕΙΔΟΠΟΙΗΣΗ
RO AVERTISMENTE
IS VIÐVÖRUN
MT TWISSIJA

HE
AR
FA
YUE 警告
CMN 警告
JA 警告
KO 경고
BG ПРЕДУПРЕЖДЕНИЕ
SR UPOZORENJE
MS AMARAN
HI चेतावनी
TH คำเตือน
SQ PARALAJMËRIM
BS UPOZORENJE
ME UPOZORENJE
MK ПРЕДУПРЕДУВАЊЕ
HY ՉԳՈՒՇԱՑՈՒՄ
VI CẢNH BÁO

אזהרה
تحذير
اخطار



EN Tutorial video
DE Videoanleitung
ES Tutorial en vídeo
FR Vidéo de démonstration
PT Video tutorial
IT Video tutorial
NL Instructievideo
PL Film instruktażowy
CS Výukové video
SK Výukové video
SL Video z navodili
HR Video s uputama
HU Bemutatóvideó
SE Videosjälvstudiekurs
NO Opplæringsvideo
FI Opetusvideo
DA Vejledende video
ET Õppevideo
LV Apmācību video
LT Mokomasis vaizdo įrašas
RU Обучающее видео
UK Навчальне відео
TR Öğretici video
EL Εκπαιδευτικό βίντεο
RO Video tutorial
IS Kennslumyndband
MT Tutorial fuq vidjow



HE
AR
FA
YUE 教程視頻
CMN 教程视频
JA チュートリアルビデオ
KO 튜토리얼 동영상
BG Учебно видео
SR Video sa uputstvima
MS Video tutorial
HI ट्यूटोरियल वीडियो
TH วิดีโอแนะนำ
SQ Video udhëzuese
BS Video sa uputstvima
ME Video sa uputstvima
MK Видеоупатство
HY Παιδαγωγικά βίντεο
VI Video hướng dẫn

ורטון הדרכה
פידיוו תעלמי
ويدئوى آموزشى

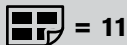

= 11

EN Maximum weights
DE Maximalgewichte
ES Pesos máximos
FR Poids maximum
PT Pesos máximos
IT Peso massimo
NL Maximumgewicht
PL Dopuszczalna waga
CS Maximální hmotnosti
SK Maximálne hmotnosti
SL Največje teže
HR Maksimalne težine
HU Maximális súlyok
SE Max.vikter
NO Maksimumsvektor
FI Enimmäispainot
DA Maksimumvægt
ET Maksimaalne kaal
LV Maksimālais svars
LT Didžiausi svoriai
RU Максимальная масса
UK Максимальна вага
TR Maksimum ağırlıklar

EL Μέγιστο βάρος
RO Greutăți maxime
IS Hámarksþyngd
MT Piżijiet massimi
HE משקלים מרביים
AR الأوزان القصوى
FA حداکثر وزن
YUE 最大重量
CMN 最大重量
JA 最大重量
KO 최대 하중
BG Максимални тегла
SR Maksimalne težine
MS Berat maksimum
HI अधिकतम बजन
TH น้ำหนักสูงสุด
SQ Peshat maksimale
BS Maksimalne težine
ME Maksimalne težine
MK Максимални тежини
HY Առավելագույն քաշեր
VI Các mức cân nặng tối đa

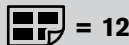

= 12

EN Product registration
DE Produktregistrierung
ES Registro del producto
FR Enregistrement du produit
PT Registo do produto
IT Registrazione del prodotto
NL Productregistratie
PL Rejestracja produktu
CS Registrace výrobku
SK Registrácia výrobku
SL Registracija izdelka
HR Registracija proizvoda
HU Termékregisztráció
SE Produktregistrering
NO Produktregistrering
FI Tuotteen rekisteröinti
DA Produktregistrering
ET Toote registreerimine
LV Produkta reģistrācija
LT Gaminio registracija
RU Регистрация продукта
UK Реєстрація продукту
TR Ürün kaydı

EL Καταχώριση προϊόντος
RO Înregistrarea produsului
IS Skráning tækis
MT Reġistrazzjoni tal-prodott
HE רישום המוצר
AR تسجيل المنتج
FA ثبت محصول
YUE 產品註冊
CMN 产品注册
JA 製品の登録
KO 제품 등록
BG Регистрация на продукта
SR Registracija proizvoda
MS Pendaftaran produk
HI उत्पाद पंजीकरण
TH การลงทะเบียนผลิตภัณฑ์
SQ Regjistrimi i produktit
BS Registracija proizvoda
ME Registracija proizvoda
MK Регистрација на производ
HY Արձարանքի գրանցում
VI Đăng ký sản phẩm



= 13

EN	Set up	EL	Στήσιμο
DE	Aufbau	RO	Setare
ES	Instalación	IS	Uppsetning
FR	Montage	MT	Konfigurazzjoni
PT	Preparação	HE	התקנה
IT	Configurazione	AR	تصويب
NL	Opbouw	FA	برپا کردن
PL	Montaż	YUE	設置
CS	Nastavení	CMN	设置
SK	Nastavenie	JA	セットアップ
SL	Nastavitev	KO	설정
HR	Postavljanje	BG	Настройка
HU	Felszerelés	SR	Postavljanje
SE	Inställning	MS	Persediaan
NO	Oppsett	HI	सेट अप
FI	Asennus	TH	การติดตั้ง
DA	Opsætning	SQ	Konfigurimi
ET	Seadistamine	BS	Postavljanje
LV	Uzstādīšana	ME	Postavljanje
LT	Nuostatos	MK	Поставување
RU	Установка	HY	Շարժափորով
UK	Встановлення	VI	Cài đặt
TR	Kurulum		



= 16

EN	Usage on the stroller frame	EL	Χρήση στο πλαίσιο του καροτσιού
DE	Verwendung auf dem Kinderwagengestell	RO	Utilizare pe cadrul căruciorului
ES	Uso en el bastidor del cochecito	IS	Notkun á ramma vagnsins
FR	Utilisation sur le cadre du landau	MT	Użu fuq il-qafas tal-pramm
PT	Utilização na estrutura do carrinho	HE	שימוש במסגרת העגלה
IT	Uso del telaio del passeggino	AR	الاستخدام على إطار عربة الأطفال
NL	Gebruik op het frame van de wandelwagen	FA	استفاده بر روی شاسی کالسکه
PL	Stosowanie na ramie wózka	YUE	在嬰兒車車架上使用
CS	Použití na rámu kočárku	CMN	在嬰兒車車架上使用
SK	Použitie na ráme kočíka	JA	ベビーカーフレームの使用
SL	Uporaba na okvirju vozička	KO	유모차 프레임 사용
HR	Upotreba na okviru kolica	BG	Употреба върху рамката на детската количка
HU	A babakocsi keretén való használat	SR	Upotreba na okviru kolica
SE	Användning på sittvagnsramen	MS	Penggunaan pada rangka kerusi tolak
NO	Bruk på barnevognrammen	HI	स्ट्रोलर फ्रेम पर उपयोग
FI	Käyttö rattaiden rungolla	TH	การใช้งานบนเฟรมรถเข็นเด็ก

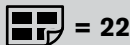

DA	Anvendelse på klapvognsstellet	SQ	Përdorimi në skeletin e karrocës	EN	Sun canopy	EL	Κουκούλα για τον ήλιο
ET	Kasutamine jalutuskäru raamil	BS	Upotreba na okviru kolica	DE	Sonnenverdeck	RO	Copertină
LV	Izmantošana uz bērnu ratiņu rāmja	ME	Upotreba na okviru kolica	ES	Capota para el sol	IS	Sólargjald
LT	Vežimėlio rėmo naudojimas	MK	Користење на рамката на количка	FR	Pare-soleil	MT	Kopertura mix-xemx
RU	Использование на раме детской коляски	HY	Մանկասայլակի կմախքի գործածութլըրընըը	PT	Capota solar	HE	שמש תפוח
UK	Використання рами візка	VI	Sử dụng trên khung xe đẩy	IT	Parasole	AR	مظلة الشمس
TR	Çocuk arabası kasasında kullanim			NL	Zonnekap	FA	سایبان
				PL	Oslona przeciwsłoneczna	YUE	遮陽蓬
				CS	Stříška proti slunci	CMN	遮阳蓬
				SK	Strieška proti slnku	JA	日よけ力/八一
				SL	Senčnik za zaščito pred soncem	KO	선 캐노피
				HR	Tenda za sunce	BG	Тента
				HU	Kupola	SR	Tenda za sunce
				SE	Solsufflett	MS	Kanopi matahari
				NO	Solskjerm	HI	धूप छतरी
				FI	Aurinkokatos	TH	หลังคาบังแดด
				DA	Solkaleche	SQ	Strea për diellin
				ET	Päikesevari	BS	Tenda za sunce
				LV	Saules aizsegs	ME	Tenda za sunce
				LT	Stogelis nuo saulės	MK	Стреа за сонце
				RU	Солнцезащитный козырек	HY	Արևասպաշտույակս ծածկ
				UK	Тент від сонця	VI	Mái che nắng
				TR	Güneş başlığı		

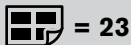

EN	Panorama view window	EL	Πανοραμικό παράθυρο	RU	Панорамное смотровое окошко
DE	Panorama-Fenster	RO	Fereastra cu vedere panoramică	UK	Панорамне віконце
ES	Ventana de visibilidad panorámica	IS	Viðmynd	TR	Panorama penceresi
FR	Fenêtre panoramique	MT	Tieqa biex tara l-veduta	HY	Պանորամային պատուհան
PT	Janela panorâmica	HE	חלון פנורמי	VI	Cửa sổ nhìn toàn cảnh
IT	Finestrino per vista panoramica	AR	نافذة بانورامية		
NL	Panoramavenster	FA	پنجره با نمای پانوراما		
PL	Okienko z panoramicznym widokiem	YUE	全景窗口		
CS	Panoramatické okno	CMN	全景窗口		
SK	Panoramatické okno	JA	パノラマビューウィンドウ		
SL	Okno s panoramskim pogledom	KO	파노라마 뷰 윈도우		
HR	Panoramski prozorčić	BG	Прозорец за панорамна гледна		
HU	Panoramikus kitekintő ablak	SR	Panorama prozorčić		
SE	Panoramafönster	MS	Tetingkap pandangan panorama		
NO	Panoramavindu	HI	पैनोरमा व्यू विंडो		
FI	Panoraamaikkuna	TH	หน้าต่างมุมมองพาโนรามา		
DA	Panoramavindue	SQ	Dritarja e shikimit panoramik		
ET	Panoraamvaatega aken	BS	Panorama prozorčić		
LV	Panorāmas skata logs	ME	Panorama prozorčić		
LT	Panoraminis langelis	MK	Панорамски прозорец		



= 24

EN Folding
DE Faltung
ES Plegado
FR Pliant
PT Fecho
IT Ripiegamento
NL Vouwen
PL Składanie
CS Skládání
SK Zloženie
SL Zlaganje
HR Preklapanje
HU Összecsukás
SE Ihopfällning
NO Sammenlegging
FI Kokoon taittaminen
DA Sammenklapning
ET Kokkuvoltimine
LV Salocīšana
LT Lankstymas
RU Складывание
UK Складання
TR Katlama

EL Αναδίπλωση
RO Pliere
IS Brjótta saman
MT Tiwi
HE
AR
FA
YUE 折疊
CMN 折疊
JA 折りたたみ
KO 접기
BG Сгъване
SR Preklapanje
MS Lipat
HI फोल्डिंग
TH การพับ
SQ Palosja
BS Preklapanje
ME Preklapanje
MK Склопување
HY Ծախելը
VI Gập lại

קיפול
 قابلة للطوي
 تا کردن



= 25

EN Rain cover
DE Regenverdeck
ES Funda para la lluvia
FR Housse de pluie
PT Capa de chuva
IT Parapioggia
NL Regenhoes
PL Osłona od deszczu
CS Pláštěnka
SK Kryt proti dažďu
SL Dežna prevleka
HR Pokrivač za kišu
HU Esővédő
SE Regnskydd
NO Kalesje
FI Sadesuoja
DA Regnslag
ET Vihmakate
LV Pretlietus pārvalks
LT Uždangalas nuo lietaus
RU Дождевик
UK Дошовник
TR Yağmurluk

EL Καλύπτρα βροχής
RO Prelată de ploaie
IS Regn yfirbreiðsla
MT Għata mix-xita
HE
AR
FA
YUE 防雨罩
CMN 防雨罩
JA 雨よけ
KO 레인커버
BG Дъждобран
SR Pokrivač za kišu
MS Pelindung hujan
HI रैन कवर
TH ฝ้ายคลุมกันฝน
SQ Mbulesë për shiun
BS Pokrivač za kišu
ME Pokrivač za kišu
MK Прекривка за дожд
HY Անձրևապաշտպան
VI Tấm che mưa

כיסוי גשם
 غطاء المطر
 روکش باران

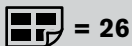

EN	Removing the fabric	EL	Αφαίρεση του υφάσματος
DE	Entfernen des Bezuges	RO	Îndepărtarea țesăturii
ES	Quitar la tela	IS	Fjarlægja efni
FR	Retrait du tissu	MT	Tneħhija tad-drapp
PT	Remover o tecido	HE	הסרת הבד
IT	Rimozione del tessuto	AR	فك القماش
NL	De stof verwijderen	FA	برداشتن پارچه
PL	Zdejmowanie pokrycia	YUE	拆除罩布
CS	Odstranění látky	CMN	拆除罩布
SK	Odstránenie látky	JA	カバーの取り外し
SL	Odstranjevanje blaga	KO	페브릭 제거
HR	Uklanjanje tkanine	BG	Демонтиране на плата
HU	Huzat eltávolítása	SR	Uklanjanje tkanine
SE	Ta bort tyget	MS	Menanggalkan fabrik
NO	Fjerne stoffet	HI	कपड़ा हटाना
FI	Kankaan poisto	TH	การถอดผ้า
DA	Fjernelse af stoffet	SQ	Heqja e copës
ET	Kanga eemaldamine	BS	Uklanjanje tkanine
LV	Pārklājuma atvienošana	ME	Uklanjanje tkanine
LT	Audinio nuėmimas	MK	Отстранување на навлаката
RU	Снятие ткани	HY	Գործվածքը հանելը
UK	Зняття матерії	VI	Tháo phần vải bọc
TR	Kılıfı çıkarma		

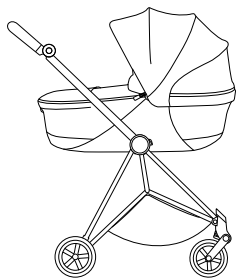

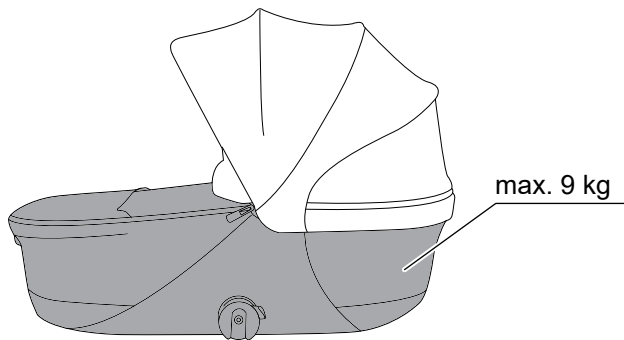

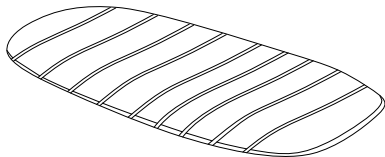
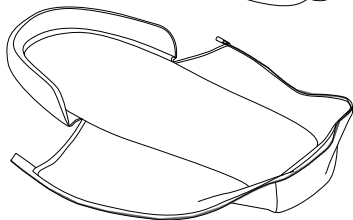
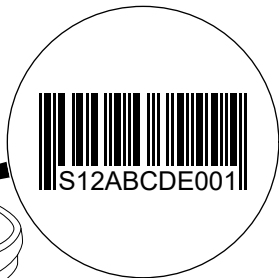
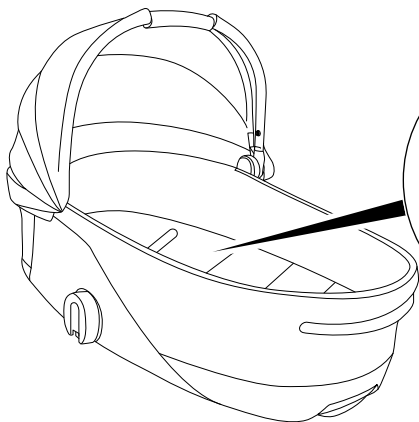

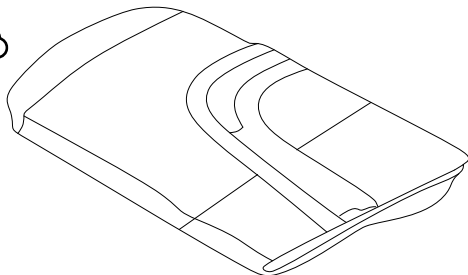
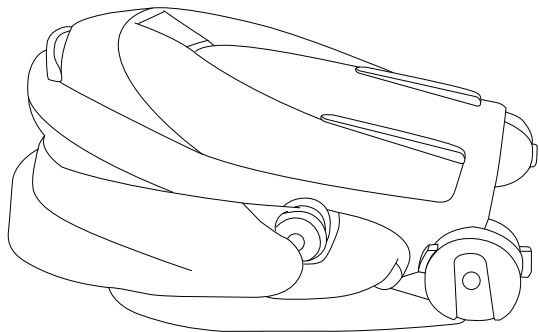

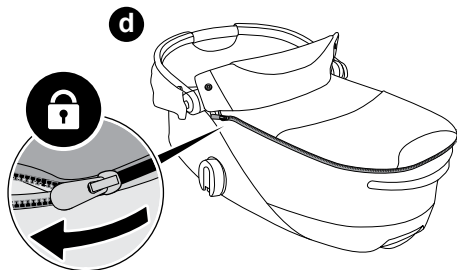
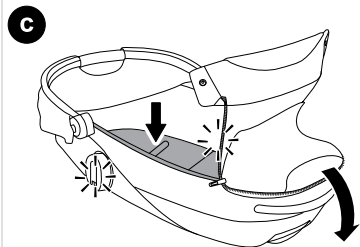
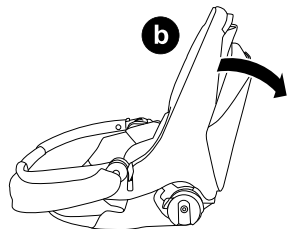
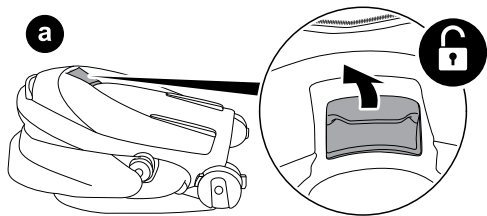

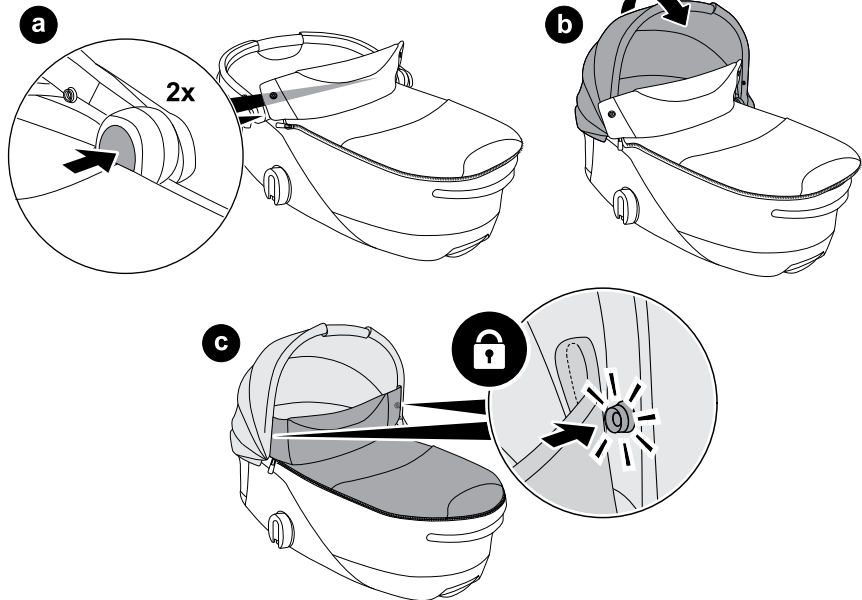



PRIAM

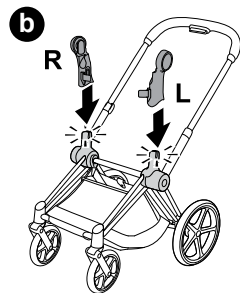
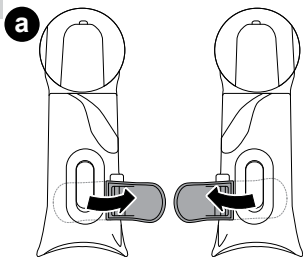

1

PRIAM

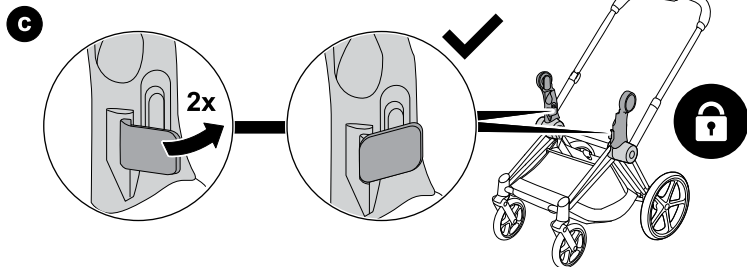

16

2

COYA

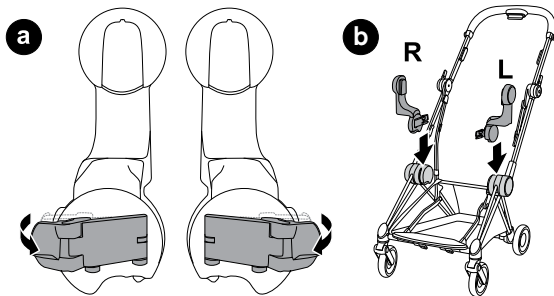

1

COYA

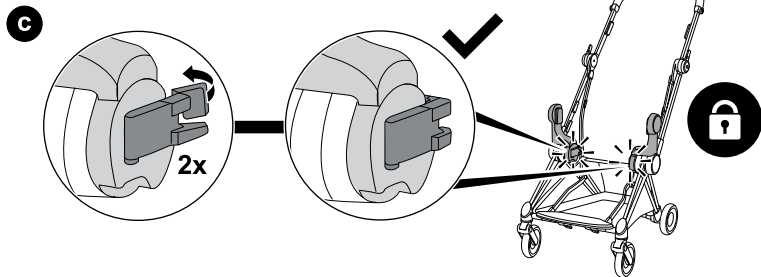

2



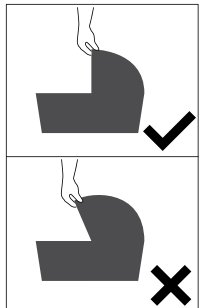
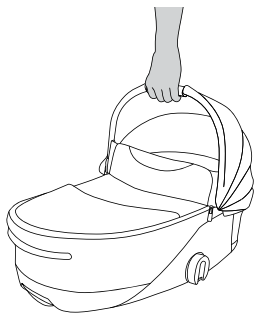
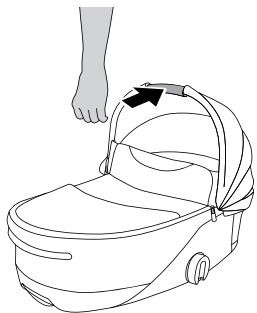

PRIAM

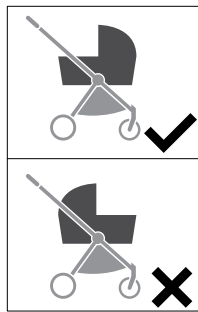
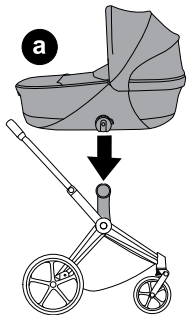

4

PRIAM

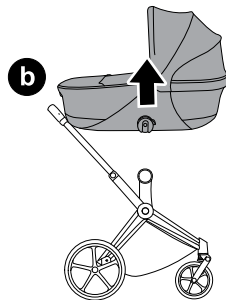
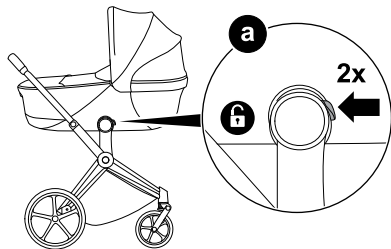

5



MIOS

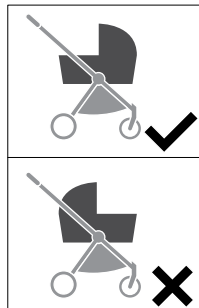
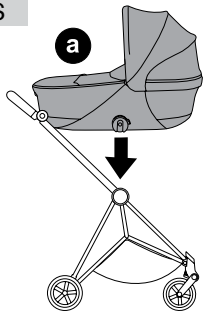

6

MIOS

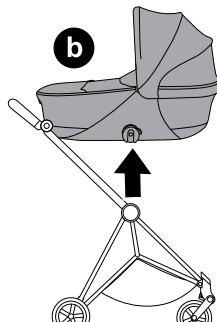
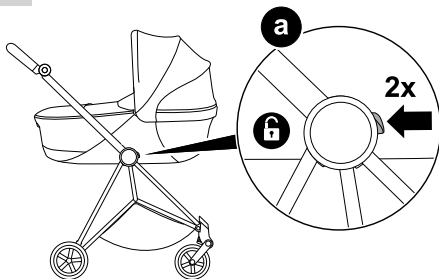

7

COYA

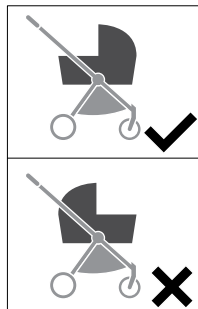
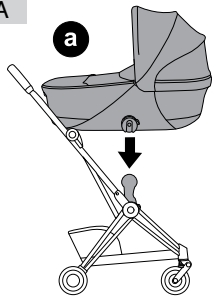

8

COYA

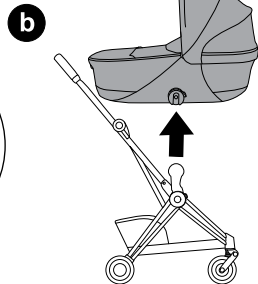
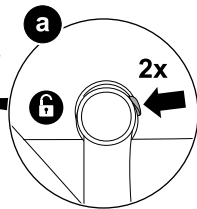
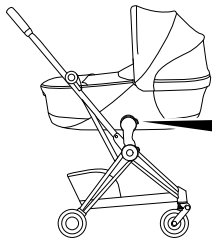

9

21

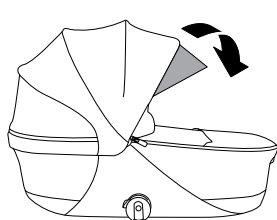
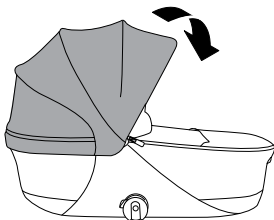
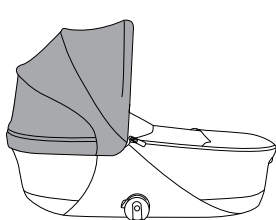
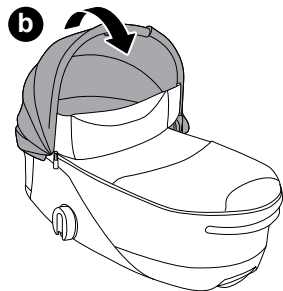
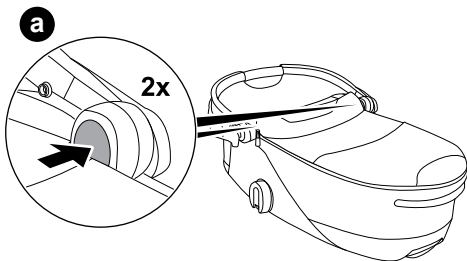

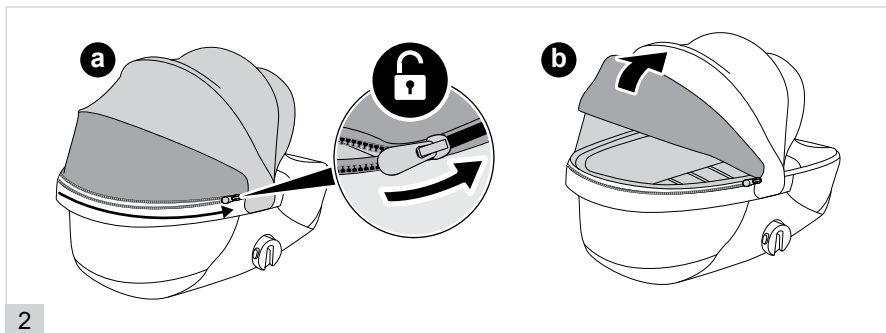
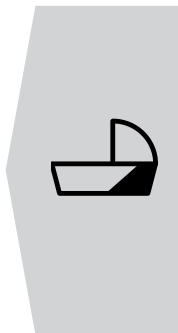
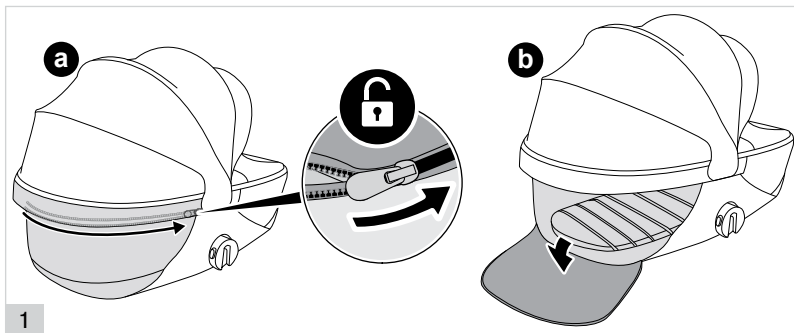

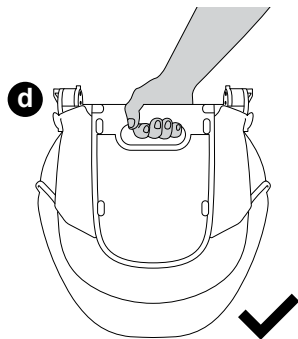
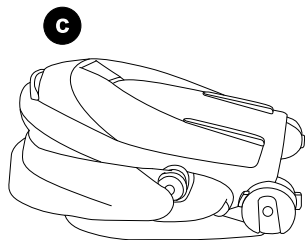
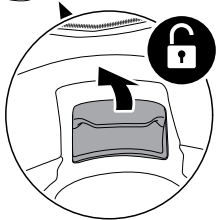
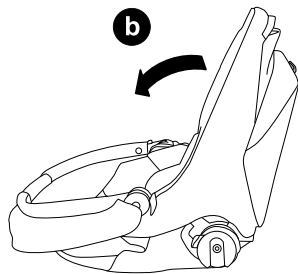
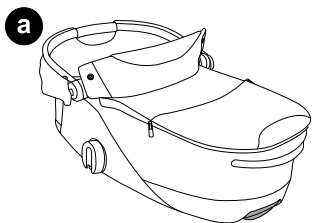

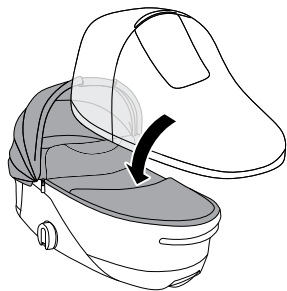

1

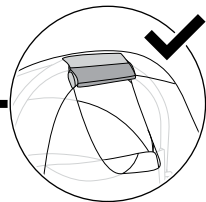
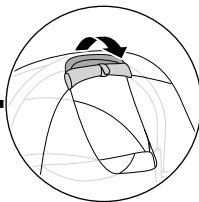
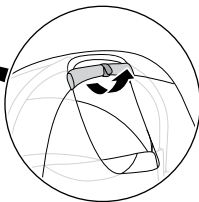

2

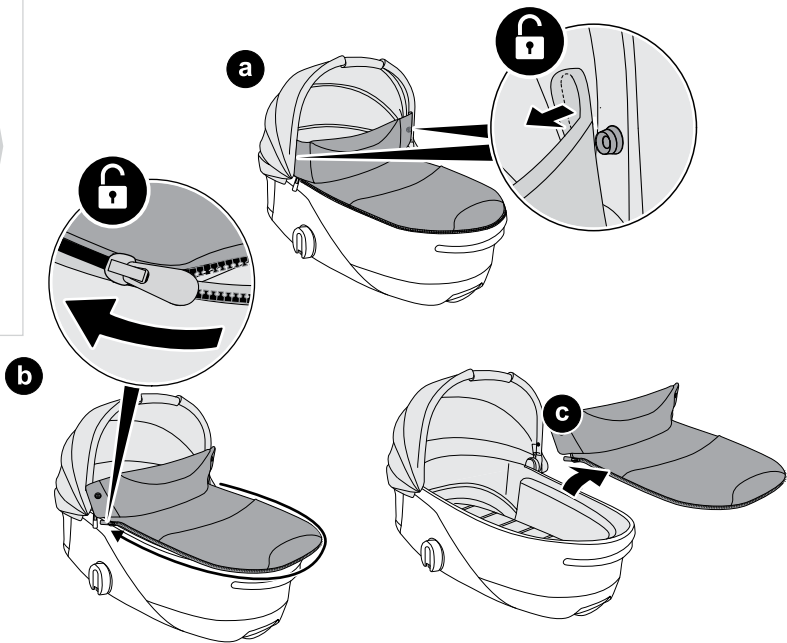

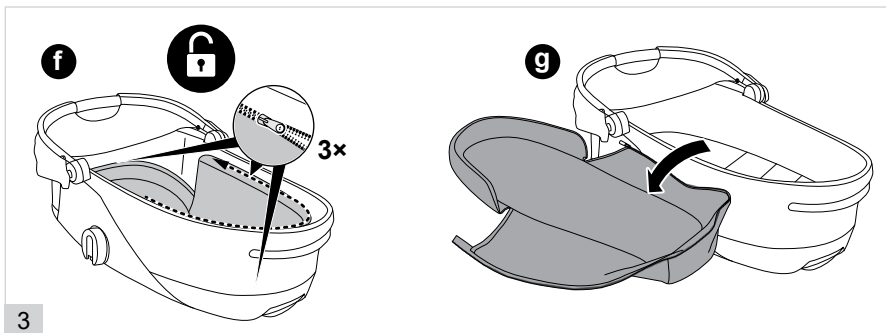
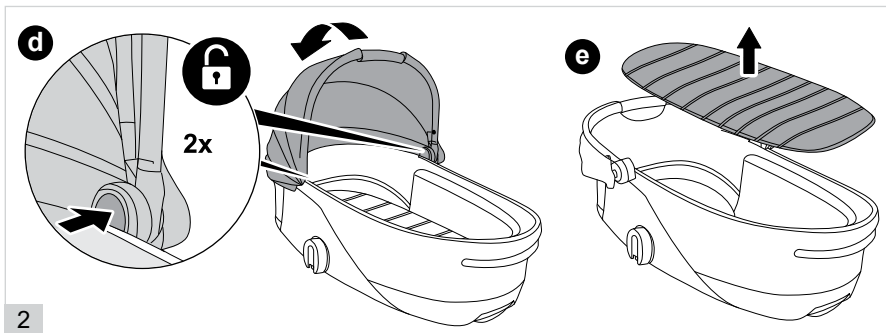

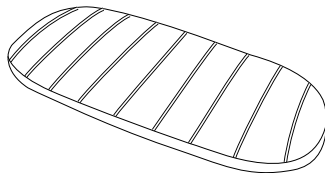
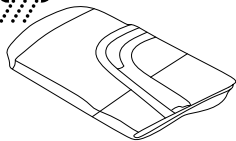
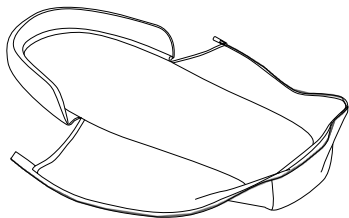
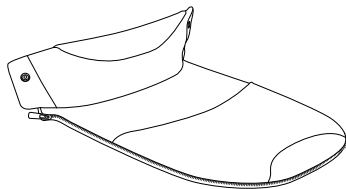
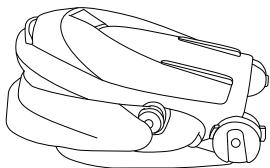



CYBEX GmbH

Riedingerstr. 18 | 95448 Bayreuth | Germany
+49 (0) 921-78 511-0 | info@cybex-online.com

www.cybex-online.com

