

**doona™**

**X™**

**Doona X ISOFIX base**  
i-Size compliant  
User guide

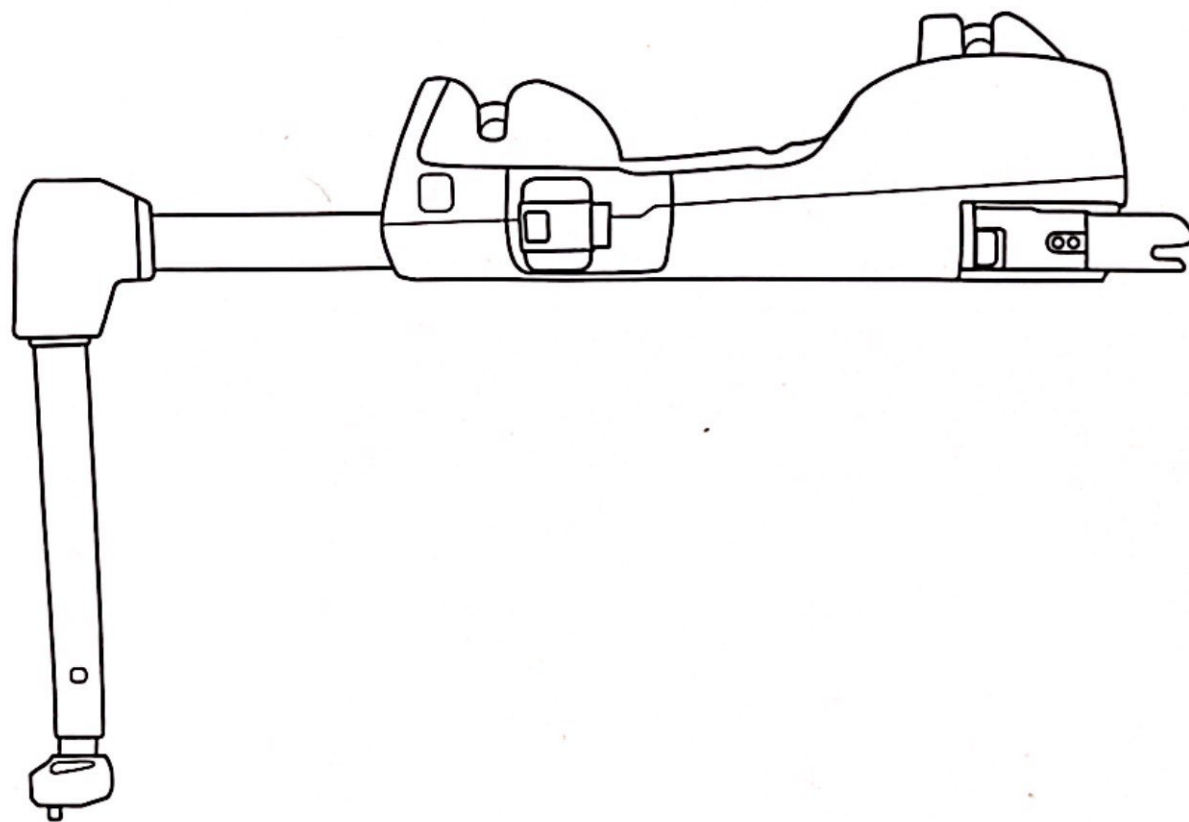

50652585

ECE R-129

Language: English

## Table of Contents

1 / Suitability	5
2 / Warnings, Important information	6
3 / Doona X ISOFIX base overview	9
4 / Use in the vehicle	12
5 / Care instructions	17
6 / Car fitting list	17
7 / Warranty	18
8 / Warranty card	19

## 1 / Suitability

The Doona X ISOFIX base is a safety product and should only be used in vehicles with ISOFIX anchor's and in combination with the Doona X.

For use in your vehicle, please also follow the vehicle manufacturer's recommendations in your owner's manual.

The Doona X ISOFIX base can be used in vehicle's on all i-Size seating positions and on ISOFIX seating positions according to the vehicle list.

## 2 / Warnings, important information

Congratulations on choosing Simple Parenting's Doona X ISOFIX base as your baby's safety and mobility solution.

In order to protect your baby, and allow easy use of the Doona X inside and outside of the car, the Doona X ISOFIX base must always be used and installed as described in these instructions.





Important – Keep these instructions for future reference. Read these instructions carefully, your child's safety may be affected if you do not follow these instructions.

Dystrybutor w Polsce:  
SCANDINAVIAN BABY Plot Dmowski Sp.k.  
Bażantów 18, 05-532 Łubna, Polska  
tel. +48 22 7506302 email: info@scandinavianbaby.pl  
www.scandinavianbaby.pl

Manufactured by: Traveler Innovations Ltd  
Made in China

## 3 / Doona X ISOFIX base overview

### **ATTENTION**

-  It is not permitted to make any modifications to the Doona X ISOFIX base. Doing so nullifies or impairs its effectiveness in protection.
-  Regularly inspect the different elements of the Doona X ISOFIX base.
-  Do not attempt to make adjustments while travelling.
-  Make sure that all movable parts of the Doona X ISOFIX base are always properly locked in place and that no parts are lodged between movable seats or doors.

- ⚠** Do not place any heavy items on the rear window shelf, these can become dangerous projectiles in the event of an accident.
- ⚠** Always fasten the Doona X ISOFIX base platform on the vehicle anchor points when used in vehicle.
- ⚠** Always make sure that the support leg foot is in contact with the vehicle floor.
- ⚠** Do not use the Doona X ISOFIX base anymore if parts have been damaged or after an accident (at an impact speed greater than 10 km/h)!

### 3 / Doona X ISOFIX base overview

- Anchor points for Doona X (4x) ..... ①
- Body slider lever ..... ②
- Release button for Doona X (2x) ..... ③
- Support leg angle indicator ..... ④
- Connector indicator for Doona X ISOFIX base locking ..... ⑤
- Support leg ..... ⑥

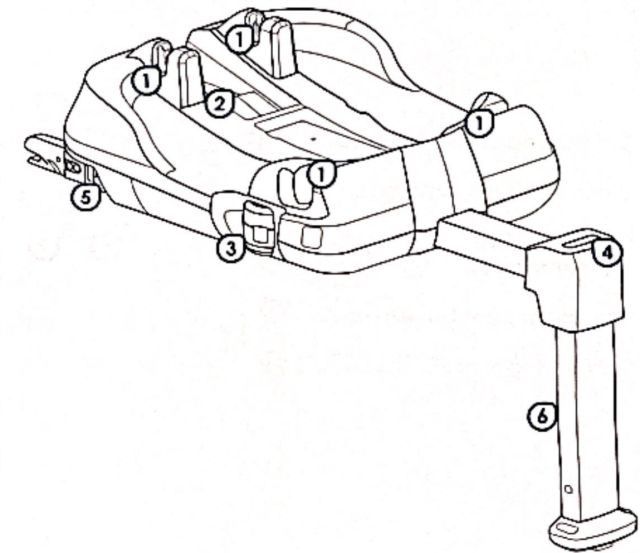

### 3 / Doona X ISOFIX base overview

- Support leg indicator..... ⑦
- Doona X ISOFIX base body..... ⑧
- Doona X ISOFIX base connectors (2x) ..... ⑨
- Leg adjustment button..... ⑩
- Support leg foot ..... ⑪

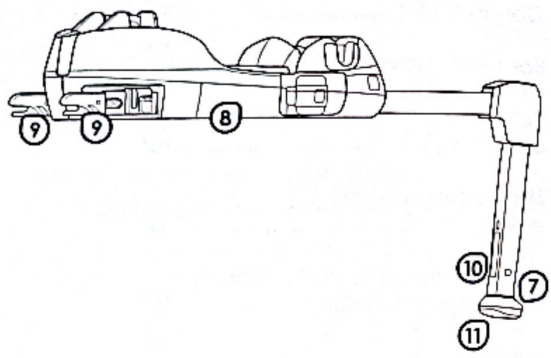

### 4 / Use in the vehicle - X anchor and metal bars

- Doona X metal bars..... ①
- Doona X ISOFIX base vehicle anchor points (2x) ..... ②

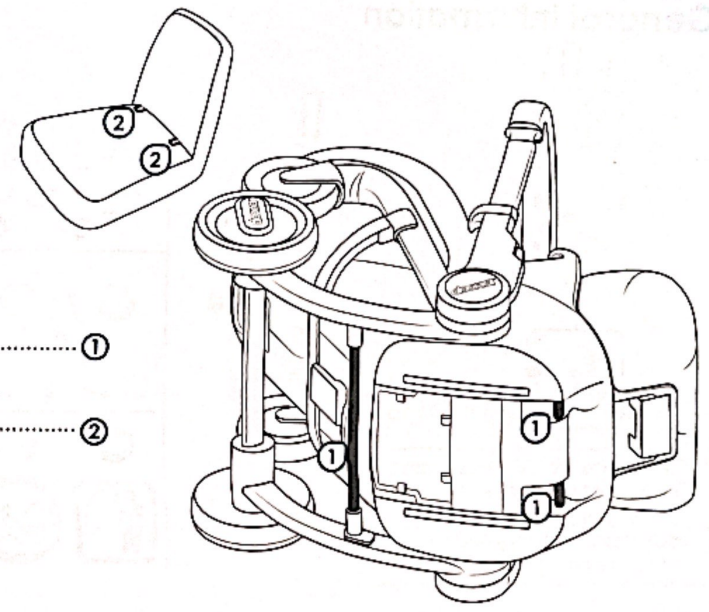

## 4 / Use in the vehicle

### General information

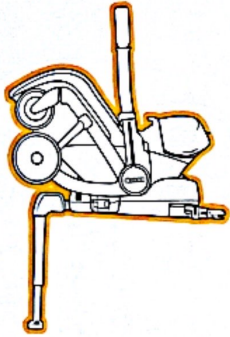

The Doona X ISOFIX base can be used on all i-size vehicle seat positions or on ISOFIX seat positions confirmed in the car fitting list.

	<p>On seats featuring ISOFIX fastening points (between seat surface and backrest) on a forward facing vehicle seat.</p>		<p>support leg must be opened and directed to the front of the car, so when a car seat is installed, it is rear facing.</p>		<ul style="list-style-type: none"> <li>• Frontal airbag</li> <li>• Side airbag</li> </ul>	<p>No Yes</p>
--	---	--	---	--	---	-------------------

## Installing the Doona X - ISOFIX base to the vehicle

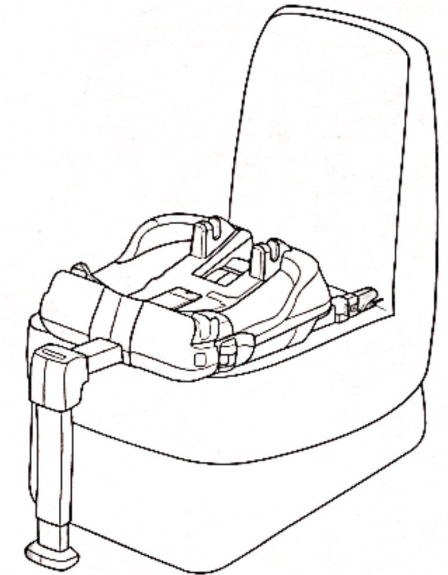
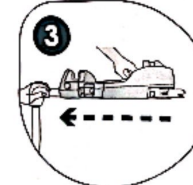
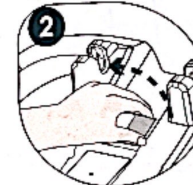
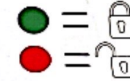
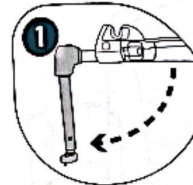

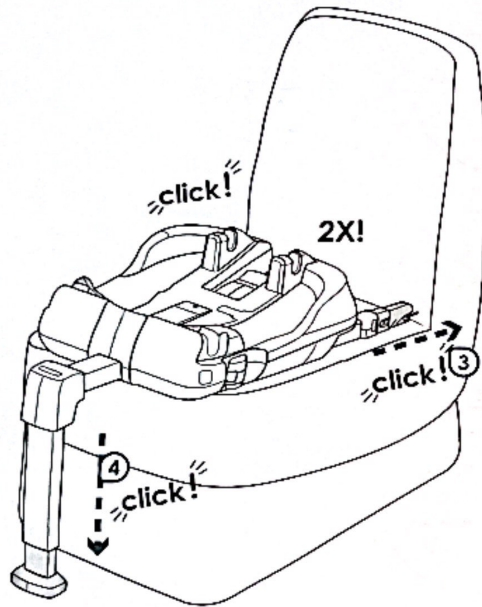
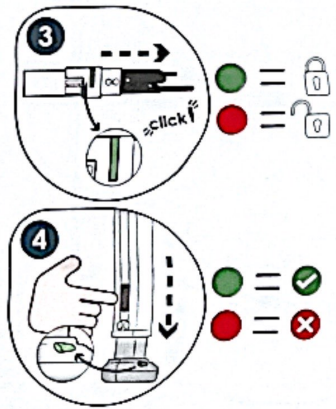

## Securing the Doona X car seat to the Doona X ISOFIX base



### **⚠ ATTENTION**

The Doona X has to be properly installed on the Doona X ISOFIX base according to the Doona X user instructions. Look up the Doona X user guide for full instructions.

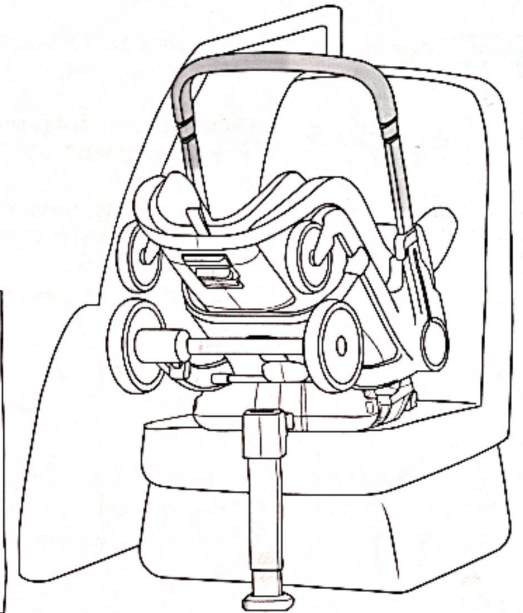

## Removing the doona X ISOFIX base from the vehicle

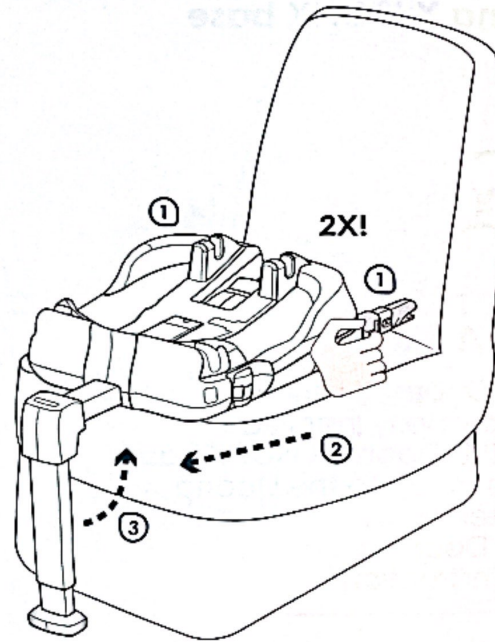
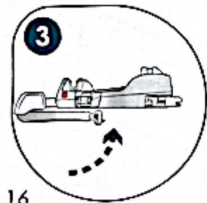
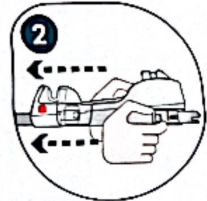
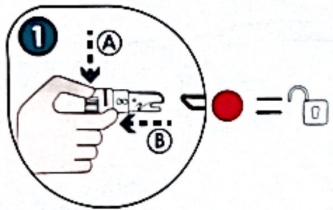

## 5 / Care instructions

It is recommended to clean the Doona X ISOFIX Base periodically, in order to keep it properly functioning.

Always remove the Doona X before cleaning the Doona X ISOFIX Base. It is also recommended to remove the Doona X ISOFIX Base from the car in order to clean it properly.

To clean the Doona X ISOFIX Base, sponge clean or rinse using warm water, soap and a rag. DO NOT use any solvents or lubrication. Using anything other than soapy water can cause the moving parts to malfunction.

## 6 / Car fitting list

This Doona X ISOFIX base fits in combination with the Doona i to all I-Size seating positions in a vehicle. Furthermore for older vehicle seating position fitting please refer to our website.



## 7 / Warranty

We guarantee that the Doona X ISOFIX Base was manufactured in accordance with the European safety standards and regulations, and it meets the highest standards of quality. For the Doona X ISOFIX Base we provide a 2-year warranty against manufacturing or material defects.

The warranty period is effective from the day of purchase. As proof of purchase we ask that you fill out the Warranty Card and retain it for the whole term of the warranty period, together with your sales receipt.

In case of a warranty claim, the Warranty Card must be returned together with the product to your local distributor.

Please also register your Doona X ISOFIX Base online at: [www.doona.com](http://www.doona.com)

The Warranty will cover a Doona X ISOFIX Base which has been handled properly.

The warranty does not apply in the following cases:

- The product shows normal signs of wear and tear.
- Damage occurs as a result of exposing the product to excessive stress.
- Damage occurs as a result of inappropriate or improper use.

## 8 / Warranty card

Please add your details below

Name: \_\_\_\_\_

Doona X ISOFIX

Base Serial number: \_\_\_\_\_

Address: \_\_\_\_\_

Retailer: \_\_\_\_\_

Post Code: \_\_\_\_\_

Date of purchase: \_\_\_\_\_

City/Town: \_\_\_\_\_

Telephone No.

(Including area code):

\_\_\_\_\_

E-mail address: \_\_\_\_\_